

FABRILcar[®]

Your partner for alternative components

powered by ASPÖCK[®]





BELEUCHTUNGSLÖSUNGEN FÜR DIVERSE ANSPRÜCHE

Die Aspöck Zweitmarke Fabrilcar bietet für jede Anforderung das ideale Produkt.

Durch die drei Kategorien Budget, Economy und Premium lässt sich klar differenzieren: Von soliden Erzeugnissen für Allround-Lösungen bis hin zu kosteneffizienten Produkten, für in die Jahre gekommene Fahrzeuge.

LIGHTING SOLUTIONS FOR DIVERSE REQUIREMENTS

The Aspöck second brand Fabrilcar offers the ideal product for every requirement.

The three categories Budget, Economy and Premium allow a clear differentiation: From solid products for all-round solutions to cost-efficient products, for vehicles that are getting on in years.

Blinklicht Direction indicator	Rücklicht Tail light	Bremslicht Stop light	Nebelschlusslicht Fog light
Rückfahrlicht Reverse light	Kennzeichenleuchte Number plate light	Rückfahralarm Reverse alarm	Umrisseleuchte End outline marker lamp
Rückstrahler weiß Reflector white	Rückstrahler rot Reflector red	Rückstrahler gelb Reflector amber	Dreieckrückstrahler Triangle reflector
Positionslicht vorne Front position light	Positionslicht hinten Rear position light	Seitenmarkierungslicht Sidemarker light	Voll LED Full LED
Bodenbeleuchtung Down light	ADR Zone 2 ADR Zone 2	Schutzart Protection	Elektromagnetische Verträglichkeit Electromagnetic compatibility
CE	Batterieladezeit in Stunden Battery charging time in hours	Batterielaufzeit in Stunden Battery working time in hours	Magnethalterung Magnetic base
E-Zulassung E-Approval	ER10-Zulassung ER10-Approval	ER23-Zulassung ER23-Approval	ER65-Zulassung ER65-Approval
Halogen	AR148-Zulassung AR148-Approval	ISO 13766-2 ISO 13766-2	

Verpackungseinheit	packaging	Kennzeichenleuchte	number plate light
links	left	Bohrloch (Anschluss)	connector details
rechts	right	Spannungsbereich	voltage range
Leuchtmittel inkludiert	light source included	Temperaturbereich	temperature range
alle Maße in mm		all dimensions in mm	

HECKLEUCHE
REAR LAMP

6-34



ARBEITSSCHEINWERFER
WORKING LAMP

35-47



MANÖVRIERLEUCHTEN
MANOUVRING LIGHTS

48



UMFELDBELEUCHTUNG
SCENE LAMP

49



SEITENMARKIERUNGSLEUCHE,
POSITIONSLEUCHE, UMRISSELEUCHE
MARKER LAMP

50-53



BLITZLEUCHE
STROBE LAMP

54-69



RUNDUMLEUCHE
BEACON

70-75



LEUCHTBALKEN
LIGHT BAR

76



KENNZEICHENLEUCHE
NUMBER PLATE LAMP

77



INNENLEUCHE
INTERIOR LAMP

78



LED KONTROLLGERÄT
LED CONTROL GEAR

79

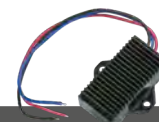

REFERENZLISTE UND BESTELNUMMERNÜBERSICHT
REFERENCE LIST AND PART NUMMERS SUMMERY

80-83



Kategorien

Drei LEVELS für FABRILCAR

Um die Orientierung zu erleichtern, sind Fabrilcar Produkte in drei Kategorien eingeteilt und im Katalog gekennzeichnet.

- PREMIUM** - Best of Fabrilcar
- ECONOMY** - Keep the balance
- BUDGET** - The bargain solution

Die exklusiv für Fabrilcar hergestellten Produkte fallen unter die Kategorie Fabrilcar Premium. Alle Premium Produkte sind mit einem eigenen Namen ausgestattet um die soliden Produkte im ansprechenden Design hervorzuheben.

Categories

Drei LEVELS für FABRILCAR

To facilitate orientation, Fabrilcar products are divided into three categories and marked in the catalogue.

- PREMIUM** - Best of Fabrilcar
- ECONOMY** - Keep the balance
- BUDGET** - The bargain solution

Products made exclusively for Fabrilcar fall under the Fabrilcar Premium category. All Premium products have their own name to highlight the solid products in an appealing design.



Service

Premiumservice aus einer Hand

Das Produkt ist ein anderes, das Service- und Vertriebsnetzwerk jedoch jenes der ASPÖCK Gruppe. Alle Kunden beider Marken genießen professionellen Support mit hohem technischen Know-how und lösungsorientiertem Service.

Premium service from one source

Although the product is a different one, the service and sales network is that of the ASPÖCK Group. All customers of both brands enjoy professional support with high technical know-how and solution-oriented service.



41-100

E



M.A.N / RENAULT / DAF

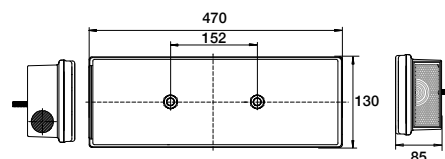
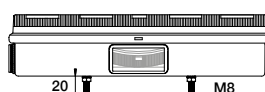
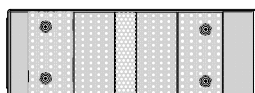

Blinklicht Direction indicator	Rücklicht Tail light	Bremslicht Stop light	Nebelschlusslicht Fog light
Rückfahrlicht Reverse light	Seitenmarkierungslicht + Reflektor Sidemarker light + reflector	Rückstrahler rot Reflector red	Kennzeichenleuchte Number plate light

BEST. NR PART NO						ZUSATZFUNKTION SPECIAL FUNCTION	ANSCHLUSS CONNECTOR	
41-1001-011	1/6	●					7 pol. AMP 7 pin AMP	33
41-1001-121	1/6		●				7 pol. AMP 7 pin AMP	33
41-1001-211	1/6	●			●		7 pol. AMP 7 pin AMP	33
41-1001-321	1/6		●		●		7 pol. AMP 7 pin AMP	33

ERSATZTEIL / SPARE PART

41-1000-001	2/28	●	●	Lichtscheibe lens				
41-1000-101	1/400	●	●	SML-Lichtscheibe SML-lens				



SCANIA / UNIVERSAL

E

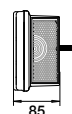
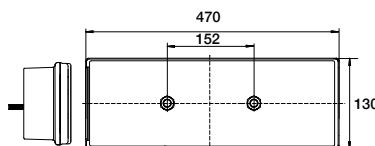
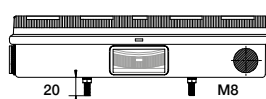
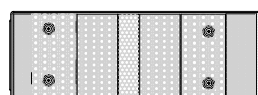

Blinklicht Direction indicator	Rücklicht Tail light	Bremslicht Stop light	Nebelschlusslicht Fog light
Rückfahrlicht Reverse light	Seitenmarkierungslicht + Reflektor Sidemarker light + reflector	Rückstrahler rot Reflector red	Kennzeichenleuchte Number plate light

BEST. NR PART NO						ZUSATZFUNKTION SPECIAL FUNCTION	ANSCHLUSS CONNECTOR		
								mm	
41-1002-011	1/6	●					Tülleneingang grommet		15
41-1002-121	1/6		●				Tülleneingang grommet		15
41-1002-211	1/6	●			●		Tülleneingang grommet		15
41-1002-321	1/6		●		●		Tülleneingang grommet		15
41-1003-011	1/6	●					offenes Ende open end	0,20 m	15
41-1003-121	1/6		●				offenes Ende open end	0,20 m	15
41-1003-211	1/6	●			●		offenes Ende open end	0,20 m	15
41-1003-321	1/6		●		●		offenes Ende open end	0,20 m	15

ERSATZTEIL / SPARE PART

41-1000-001	2/28	●	●	Lichtscheibe lens				
41-1000-101	1/400	●	●	SML-Lichtscheibe SML-lens				

41-100

UNIVERSAL

E

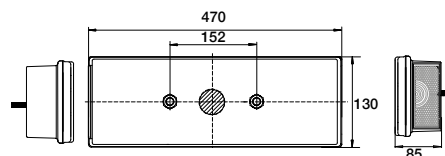
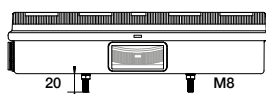
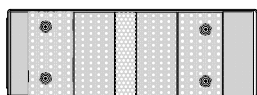

Blinklicht Direction indicator	Rücklicht Tail light	Bremslicht Stop light	Nebelschlusslicht Fog light
Rückfahrlicht Reverse light	Seitenmarkierungslicht + Reflektor Sidemarker light + reflector	Rückstrahler rot Reflector red	Kennzeichenleuchte Number plate light

BEST. NR PART NO						ZUSATZFUNKTION SPECIAL FUNCTION	ANSCHLUSS CONNECTOR		
mm									
41-1004-011	1/6	●					offenes Ende open end	0,20 m	15
41-1004-121	1/6		●				offenes Ende open end	0,20 m	15
41-1004-211	1/6	●			●		offenes Ende open end	0,20 m	15
41-1004-321	1/6		●		●		offenes Ende open end	0,20 m	15
41-1005-011	1/6	●					PG 11 Verschraubung cable glands 11		19
41-1005-121	1/6		●				PG 11 Verschraubung cable glands 11		19
41-1005-211	1/6	●			●		PG 11 Verschraubung cable glands 11		19
41-1005-321	1/6		●		●		PG 11 Verschraubung cable glands 11		19

ERSATZTEIL / SPARE PART

41-1000-001	2/28	●	●	Lichtscheibe lens				
41-1000-101	1/400	●	●	SML-Lichtscheibe SML-lens				



M.A.N / STEYR

E

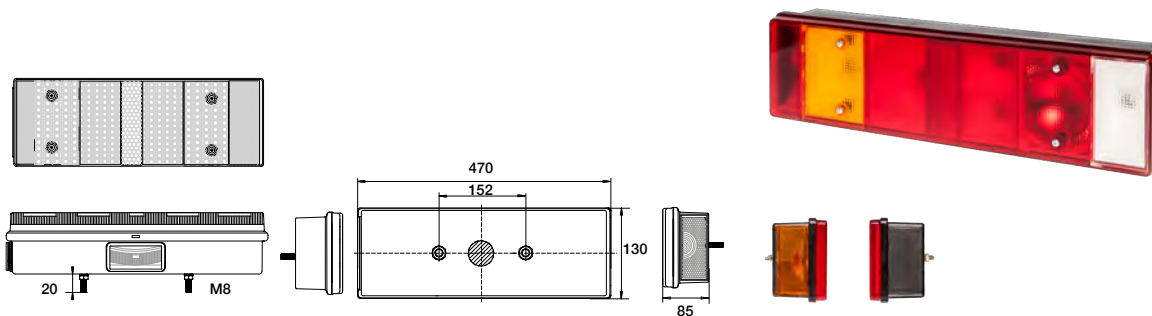

Blinklicht Direction indicator	Rücklicht Tail light	Bremslicht Stop light	Nebelschlusslicht Fog light
Rückfahrlicht Reverse light	Seitenmarkierungslicht + Reflektor Sidemarker light + reflector	Rückstrahler rot Reflector red	Kennzeichenleuchte Number plate light

BEST. NR PART NO						ZUSATZFUNKTION SPECIAL FUNCTION	ANSCHLUSS CONNECTOR	
41-1006-011	1/6	●					8 pol. Schlemmer 8 pin Schlemmer	35
41-1006-121	1/6		●				8 pol. Schlemmer 8 pin Schlemmer	35
41-1006-211	1/6	●			●		8 pol. Schlemmer 8 pin Schlemmer	35
41-1006-321	1/6		●		●		8 pol. Schlemmer 8 pin Schlemmer	35

ERSATZTEIL / SPARE PART								
41-1000-001	2/28	●	●	Lichtscheibe lens				
41-1000-101	1/400	●	●	SML-Lichtscheibe SML-lens				

41-100

DAF

E

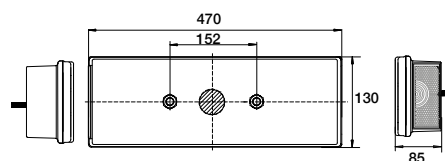
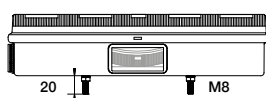
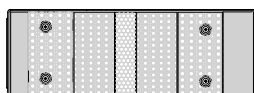

Blinklicht Direction indicator	Rücklicht Tail light	Bremslicht Stop light	Nebelschlusslicht Fog light
Rückfahrlicht Reverse light	Seitenmarkierungslicht + Reflektor Sidemarker light + reflector	Rückstrahler rot Reflector red	Kennzeichenleuchte Number plate light

BEST. NR PART NO						ZUSATZFUNKTION SPECIAL FUNCTION	ANSCHLUSS CONNECTOR	
41-1007-011	1/6	●					8 pol. DAF 8 pin DAF	
41-1007-121	1/6		●				8 pol. DAF 8 pin DAF	
41-1007-211	1/6	●			●		8 pol. DAF 8 pin DAF	
41-1007-321	1/6		●		●		8 pol. DAF 8 pin DAF	

ERSATZTEIL / SPARE PART

41-1000-001	2/28	●	●	Lichtscheibe lens				
41-1000-101	1/400	●	●	SML-Lichtscheibe SML-lens				



VOLVO

E

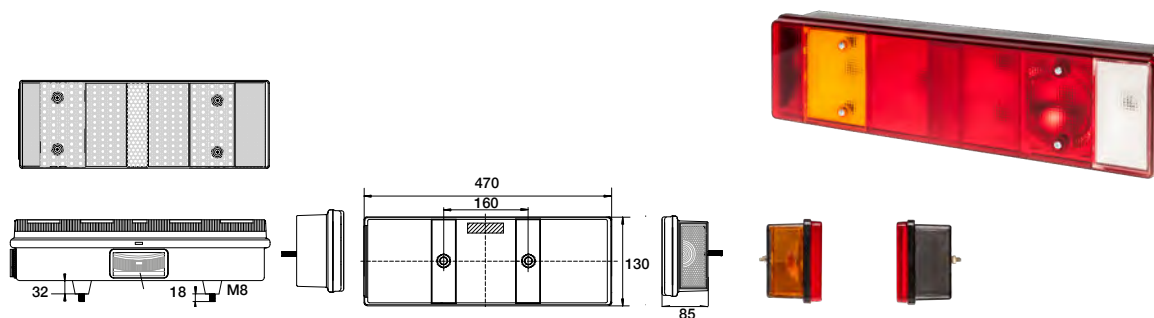

Blinklicht Direction indicator	Rücklicht Tail light	Bremslicht Stop light	Nebelschlusslicht Fog light
Rückfahrlicht Reverse light	Seitenmarkierungslicht + Reflektor Sidemarker light + reflector	Rückstrahler rot Reflector red	Kennzeichenleuchte Number plate light

BEST. NR PART NO						ZUSATZFUNKTION SPECIAL FUNCTION	ANSCHLUSS CONNECTOR	
41-1008-011	1/6	●					8 pol. VOLVO 8 pin VOLVO	71
41-1008-121	1/6		●				8 pol. VOLVO 8 pin VOLVO	71
41-1008-211	1/6	●			●		8 pol. VOLVO 8 pin VOLVO	71
41-1008-321	1/6		●		●		8 pol. VOLVO 8 pin VOLVO	71

ERSATZTEIL / SPARE PART								
41-1000-001	2/28	●	●	Lichtscheibe lens				
41-1000-101	1/400	●	●	SML-Lichtscheibe SML-lens				

41-100

IVECO

E

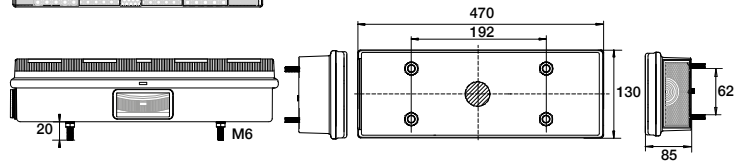
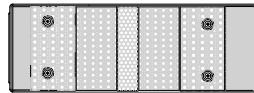

Blinklicht Direction indicator	Rücklicht Tail light	Bremslicht Stop light	Nebelschlusslicht Fog light
Rückfahrlicht Reverse light	Seitenmarkierungslicht + Reflektor Sidemarker light + reflector	Rückstrahler rot Reflector red	Kennzeichenleuchte Number plate light

BEST. NR PART NO						ZUSATZFUNKTION SPECIAL FUNCTION	ANSCHLUSS CONNECTOR	
41-1009-011	1/6	●					10 pol. IVECO 10 pin IVECO	50
41-1009-111	1/6	●			●		10 pol. IVECO + 10 pin IVECO +	50
41-1009-221	1/6		●				10 pol. IVECO 10 pin IVECO	50
41-1009-321	1/6		●		●		10 pol. IVECO + 10 pin IVECO +	50

ERSATZTEIL / SPARE PART

41-1000-001	2/28	●	●	Lichtscheibe lens				
41-1000-101	1/400	●	●	SML-Lichtscheibe SML-lens				



MAN / RENAULT / FRUEHAUF / UNIVERSAL

E

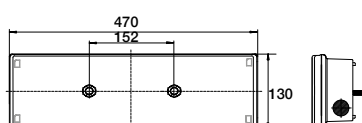
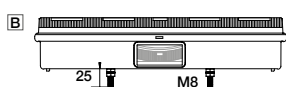
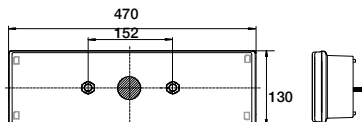
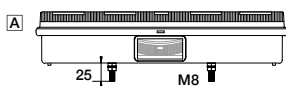
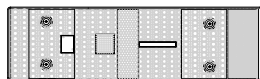

Blinklicht
Direction indicator



Rücklicht
Tail light



Bremslicht
Stop light



Nebelschlusslicht
Fog light



Rückfahrlicht
Reverse light



Rückstrahler rot
Reflector red



Kennzeichenleuchte
Number plate light

BEST. NR						ZUSATZFUNKTION	ANSCHLUSS	
PART NO						SPECIAL FUNCTION	CONNECTOR	mm
41-1011-011	1/6	●			●		PG 11 Verschraubung cable glands 11	A
41-1011-121	1/6		●		●		PG 11 Verschraubung cable glands 11	A
41-1011-211	1/6	●					PG 11 Verschraubung cable glands 11	A
41-1011-321	1/6		●				PG 11 Verschraubung cable glands 11	A
41-1012-011	1/6	●					7 pol. AMP 7 pin AMP	B
41-1012-121	1/6		●				7 pol. AMP 7 pin AMP	B
41-1012-211	1/6	●			●		7 pol. AMP 7 pin AMP	B
41-1012-321	1/6		●		●		7 pol. AMP 7 pin AMP	B

ERSATZTEIL / SPARE PART

41-1010-001	2/28	●	●	Lichtscheibe lens				
-------------	------	---	---	----------------------	--	--	--	--

41-102

E



VOLVO

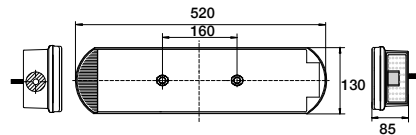
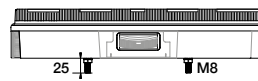
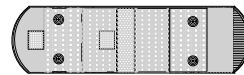

Blinklicht Direction indicator	Rücklicht Tail light	Bremslicht Stop light	Nebelschlusslicht Fog light
Rückfahrlicht Reverse light	Seitenmarkierungslicht + Reflektor Sidemarker light + reflector	Rückstrahler rot Reflector red	Kennzeichenleuchte Number plate light

BEST. NR PART NO						ZUSATZFUNKTION SPECIAL FUNCTION	ANSCHLUSS CONNECTOR	
41-1021-001	1/6	●	●				7 pol. AMP VOLVO 7 pin AMP VOLVO	24
41-1021-111	1/6	●			●		7 pol. AMP VOLVO 7 pin AMP VOLVO	24
41-1021-221	1/6		●		●		7 pol. AMP VOLVO 7 pin AMP VOLVO	24

ERSATZTEIL / SPARE PART

41-1020-001	1/17	●	●	Lichtscheibe lens				
-------------	------	---	---	----------------------	--	--	--	--

SCANIA

E

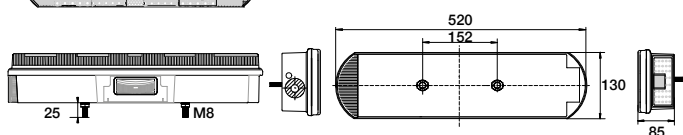
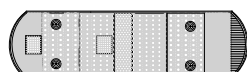

Blinklicht Direction indicator	Rücklicht Tail light	Bremslicht Stop light	Nebelschlusslicht Fog light
Rückfahrlicht Reverse light	Seitenmarkierungslicht + Reflektor Sidemarker light + reflector	Rückstrahler rot Reflector red	Kennzeichenleuchte Number plate light

BEST. NR PART NO						ZUSATZFUNKTION SPECIAL FUNCTION	ANSCHLUSS CONNECTOR	
41-1021-301	1/6	●	●				7 pol. AMP SCANIA 7 pin AMP SCANIA	24
41-1021-411	1/6	●			●		7 pol. AMP SCANIA 7 pin AMP SCANIA	24
41-1021-521	1/6		●		●		7 pol. AMP SCANIA 7 pin AMP SCANIA	24
41-1021-601	1/6	●			●		7 pol. AMP SCANIA 7 pin. AMP SCANIA	24
41-1021-611	1/6		●				7 pol. AMP SCANIA 7 pin. AMP SCANIA	24
41-1021-621	1/6		●		●		7 pol. AMP SCANIA 7 pin. AMP SCANIA	24

ERSATZTEIL / SPARE PART

41-1020-001	1/17	●	●	Lichtscheibe lens				
-------------	------	---	---	----------------------	--	--	--	--

41-102

SCANIA / UNIVERSAL

E

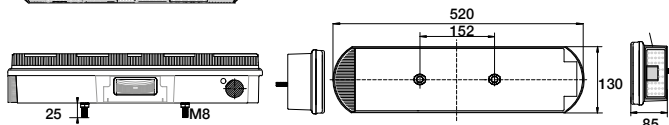
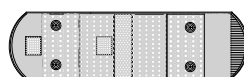

Blinklicht Direction indicator	Rücklicht Tail light	Bremslicht Stop light	Nebelschlusslicht Fog light
Rückfahrlicht Reverse light	Seitenmarkierungslicht + Reflektor Sidemarker light + reflector	Rückstrahler rot Reflector red	Kennzeichenleuchte Number plate light

BEST. NR PART NO						ZUSATZFUNKTION SPECIAL FUNCTION	ANSCHLUSS CONNECTOR	
ERSATZTEIL / SPARE PART								
41-1022-021	1/6		●				Tülleneingang grommet	15
41-1022-111	1/6	●					Tülleneingang grommet	15
41-1022-211	1/6	●			●		Tülleneingang grommet	15
41-1022-321	1/6		●		●		Tülleneingang grommet	15
41-1023-021	1/6		●				offenes Ende open end	0,20 m 15
41-1023-111	1/6	●					offenes Ende open end	0,20 m 15
41-1023-211	1/6	●			●		offenes Ende open end	0,20 m 15
41-1023-321	1/6		●		●		offenes Ende open end	0,20 m 15
41-1020-001	1/17	●	●	Lichtscheibe lens				



VOLVO

E

nicht erhältlich in UK
not available in UK

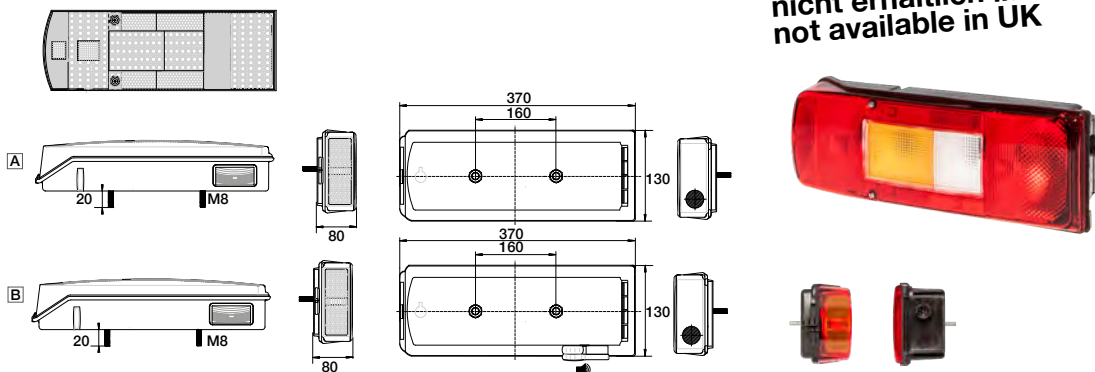

Blinklicht Direction indicator	Rücklicht Tail light	Bremslicht Stop light	Nebelschlusslicht Fog light
Rückfahrlicht Reverse light	Seitenmarkierungslicht + Reflektor Sidemarker light + reflector	Rückstrahler rot Reflector red	Kennzeichenleuchte Number plate light

BEST. NR PART NO						ZUSATZFUNKTION SPECIAL FUNCTION	ANSCHLUSS CONNECTOR	
								mm
41-1031-021	1/10		●				7 pol. AMP 7 pin AMP 	26
41-1031-121	1/10		●			Rückfahralarm Reverse alarm	7 pol. AMP 7 pin AMP 	26
41-1031-211	1/10	●			●		7 pol. AMP 7 pin AMP 	26

ERSATZTEIL / SPARE PART								
41-1030-001	2/20	●	●	Lichtscheibe lens				

41-104

VOLVO

E

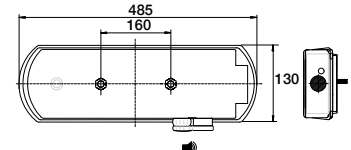
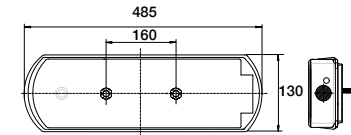
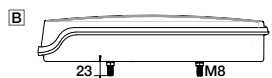
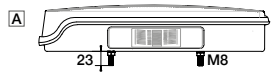

Blinklicht
Direction indicator



Rücklicht
Tail light



Bremslicht
Stop light



Nebelschlusslicht
Fog light



Rückfahrlicht
Reverse light

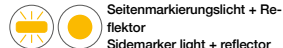

Seitenmarkierungslicht + Reflektor
Sidemarker light + reflector



Rückstrahler rot
Reflector red

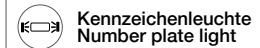

Kennzeichenleuchte
Number plate light

BEST. NR						ZUSATZFUNKTION	ANSCHLUSS	
PART NO						SPECIAL FUNCTION	CONNECTOR	mm
41-1041-011	1/6	●					7 pol. AMP 7 pin AMP	A
41-1041-121	1/6		●				7 pol. AMP 7 pin AMP	A
41-1041-221	1/6		●			Rückfahralarm Reverse alarm	7 pol. AMP 7 pin AMP	B
41-1041-311	1/6	●			●		7 pol. AMP 7 pin AMP	A

ERSATZTEIL / SPARE PART

41-1040-001	2/12	●	●			Lichtscheibe lens		
-------------	------	---	---	--	--	----------------------	--	--



MERCEDES BENZ / ACTROS

E

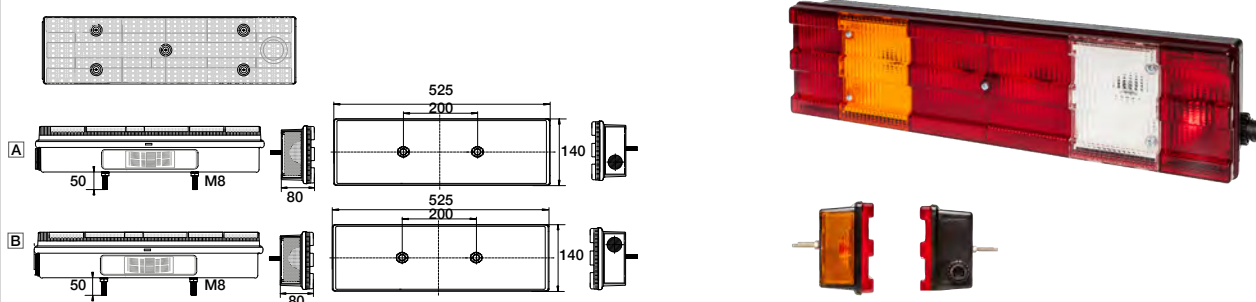

Blinklicht Direction indicator	Rücklicht Tail light	Bremslicht Stop light	Nebelschlusslicht Fog light
Rückfahrlicht Reverse light	Seitenmarkierungslicht + Reflektor Sidemarker light + reflector	Rückstrahler rot Reflector red	Kennzeichenleuchte Number plate light

BEST. NR PART NO						ZUSATZFUNKTION SPECIAL FUNCTION	ANSCHLUSS CONNECTOR	
								mm
41-1051-011	1/4	●					7 pol. AMP 7 pin AMP A	33
41-1051-121	1/4		●				7 pol. AMP 7 pin AMP A	33
41-1051-211	1/4	●			●		7 pol. AMP 7 pin AMP A	33
41-1051-321	1/4		●		●		7 pol. AMP 7 pin AMP A	33
41-1051-411	1/4	●			●		7 pol. AMP 7 pin AMP B	33
41-1051-521	1/4		●				7 pol. AMP 7 pin AMP B	33

ERSATZTEIL / SPARE PART

41-1050-011	1/17	●		Lichtscheibe lens				
41-1050-121	1/17		●	Lichtscheibe lens				

41-105

E



MERCEDES BENZ SK

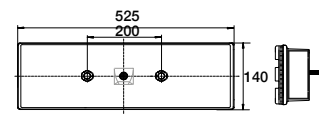
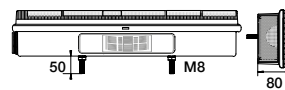

Blinklicht Direction indicator	Rücklicht Tail light	Bremslicht Stop light	Nebelschlusslicht Fog light
Rückfahrlicht Reverse light	Seitenmarkierungslicht + Reflektor Sidemarker light + reflector	Rückstrahler rot Reflector red	Kennzeichenleuchte Number plate light

BEST. NR PART NO						ZUSATZFUNKTION SPECIAL FUNCTION	ANSCHLUSS CONNECTOR	
41-1052-011	1/4	●					8 pol. AMP mit 1,44 m Kabel 8 pin AMP with 1,44 m cable	22
41-1052-121	1/4		●				8 pol. AMP mit 1,44 m Kabel 8 pin AMP with 1,44 m cable	22
41-1052-211	1/4	●			●		8 pol. AMP mit 1,44 m Kabel 8 pin AMP with 1,44 m cable	22
41-1052-321	1/4		●		●		8 pol. AMP mit 1,44 m Kabel 8 pin AMP with 1,44 m cable	22

ERSATZTEIL / SPARE PART

41-1050-011	1/17	●		Lichtscheibe lens				
41-1050-121	1/17		●	Lichtscheibe lens				

E



MERCEDES BENZ / SPRINTER ATEGO / UNIVERSAL

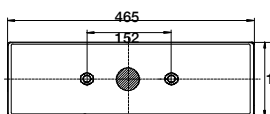
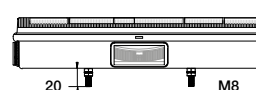
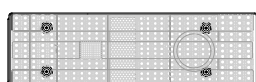

Blinklicht Direction indicator	Rücklicht Tail light	Bremslicht Stop light	Nebelschlusslicht Fog light
Rückfahrlicht Reverse light	Seitenmarkierungslicht + Reflektor Sidemarker light + reflector	Rückstrahler rot Reflector red	Kennzeichenleuchte Number plate light

BEST. NR PART NO						ZUSATZFUNKTION SPECIAL FUNCTION	ANSCHLUSS CONNECTOR	
mm								
41-1061-021	1/6		●				PG 11 Verschraubung cable glands 11	
41-1061-111	1/6	●					PG 11 Verschraubung cable glands 11	
41-1061-221	1/6		●		●		PG 11 Verschraubung cable glands 11	
41-1061-311	1/6	●			●		PG 11 Verschraubung cable glands 11	
41-1062-021	1/6		●				8 pol. Schlemmer 8 pin Schlemmer	
41-1062-111	1/6	●					8 pol. Schlemmer 8 pin Schlemmer	
41-1062-221	1/6		●		●		8 pol. Schlemmer 8 pin Schlemmer	
41-1062-311	1/6	●			●		8 pol. Schlemmer 8 pin Schlemmer	
41-1063-021	1/6		●				offenes Ende open end	0,20 m
41-1063-111	1/6	●					offenes Ende open end	0,20 m
41-1063-221	1/6		●		●		offenes Ende open end	0,20 m
41-1063-311	1/6	●			●		offenes Ende open end	0,20 m

ERSATZTEIL / SPARE PART

41-1060-001	1/17	●	●	Lichtscheibe lens				
-------------	------	---	---	----------------------	--	--	--	--

41-107

E



KÖGEL / SCHMITZ / UNIVERSAL

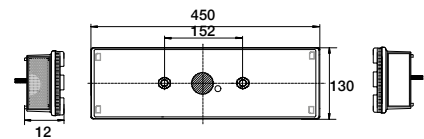
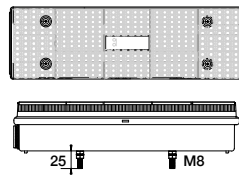

Blinklicht Direction indicator	Rücklicht Tail light	Bremslicht Stop light	Nebelschlusslicht Fog light
Rückfahrlicht Reverse light	Seitenmarkierungslicht + Reflektor Sidemarker light + reflector		

BEST. NR					ZUSATZFUNKTION	ANSCHLUSS	
PART NO					SPECIAL FUNCTION	CONNECTOR	mm
41-1071-001	1/6	●	●			6 pol. SKK 6 pin SKK	44
41-1072-001	1/6	●	●			PG 11 Verschraubung cable glands 11	19
41-1073-001	1/6	●	●			6 pol. SKK mit 1,44 m Kabel 6 pin SKK with 1,44 m cable	44

ERSATZTEIL / SPARE PART

41-1070-001	1/18	●	●	Lichtscheibe lens			
-------------	------	---	---	----------------------	--	--	--



IVECO-DAILY / EURO CARGO

E

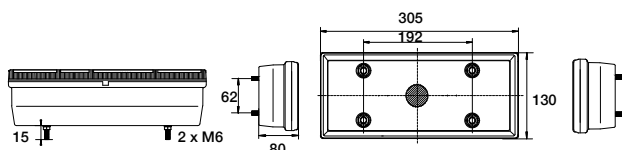

Blinklicht Direction indicator	Rücklicht Tail light	Bremslicht Stop light	Rückstrahler rot Reflector red
-----------------------------------	-------------------------	--------------------------	-----------------------------------

BEST. NR						ZUSATZFUNKTION	ANSCHLUSS	
PART NO						SPECIAL FUNCTION	CONNECTOR	mm
41-1081-011	1/10	●				Nebelschlusslicht Fog light	6 pol. 6 pin	48
41-1081-121	1/10		●			Rückfahrlicht Reverse light	6 pol. 6 pin	48
41-1081-211	1/10	●				Rückfahrlicht Reverse light	6 pol. 6 pin	48
41-1081-321	1/10		●			Nebelschlusslicht Fog light	6 pol. 6 pin	48
41-1082-011	1/10	●				Nebelschlusslicht Fog light	10 pol. / 3 pol. links 10 pin / 3 pin left	50/41
41-1082-121	1/10		●			Rückfahrlicht Reverse light	10 pol. / 3 pol. rechts 10 pin / 3 pin right	50/41
41-1082-211	1/10	●				Rückfahrlicht Reverse light	10 pol. / 3 pol. links 10 pin / 3 pin left	50/41
41-1082-321	1/10		●			Nebelschlusslicht Fog light	10 pol. / 3 pol. rechts 10 pin / 3 pin right	50/41
41-1083-011	1/10	●				Nebelschlusslicht Fog light	7 pol. AMP 7 pin AMP	24
41-1083-121	1/10		●			Rückfahrlicht Reverse light	7 pol. AMP 7 pin AMP	24
41-1083-211	1/10	●				Rückfahrlicht Reverse light	7 pol. AMP 7 pin AMP	24
41-1083-321	1/10		●			Nebelschlusslicht Fog light	7 pol. AMP 7 pin AMP	24

ERSATZTEIL / SPARE PART

41-1080-011	2/42	●		Lichtscheibe lens	Nebelschlusslicht Fog light
41-1080-121	2/42		●	Lichtscheibe lens	Rückfahrlicht Reverse light
41-1080-211	2/42	●		Lichtscheibe lens	Rückfahrlicht Reverse light
41-1080-321	2/42		●	Lichtscheibe lens	Nebelschlusslicht Fog light

41-109

E



IVECO - DAILY

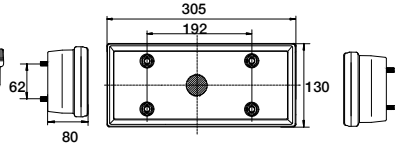
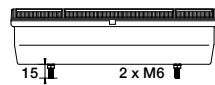
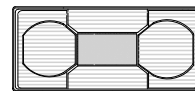

Blinklicht
Direction indicator

Rücklicht
Tail light

Bremslicht
Stop light

Nebelschlusslicht
Fog light

Rückfahrlicht
Reverse light

Rückstrahler rot
Reflector red

BEST. NR						ZUSATZFUNKTION	ANSCHLUSS	
PART NO						SPECIAL FUNCTION	CONNECTOR	mm
41-1091-011	1/10	●					7 pol. AMP links 7 pin AMP left	33
41-1091-121	1/10		●				7 pol. AMP rechts 7 pin AMP right	33

ERSATZTEIL / SPARE PART

41-1090-001	2/42	●	●	Lichtscheibe lens				
-------------	------	---	---	----------------------	--	--	--	--

LED IP 67 E



HECKLEUCHE / REAR LAMP

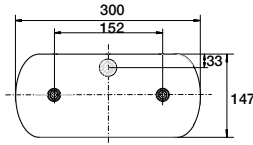
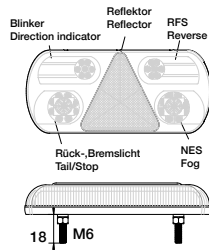

Blinklicht Direction indicator	Rücklicht Tail light	Bremslicht Stop light	Nebelschlusslicht Fog light
Rückfahrlicht Reverse light		Dreieckrückstrahler Triangle reflector	

BEST. NR PART NO		←	→		⚡ V	ZUSATZFUNKTION	ANSCHLUSS	mm	
						SPECIAL FUNCTION	CONNECTOR		
41-1300-011	1/10	●			10-30		offenes Ende open end	0,48 m	20
41-1300-121	1/10		●		10-30		offenes Ende open end	0,48 m	20

41-131

LED IP 64 E



HECKLEUCHE / REAR LAMP

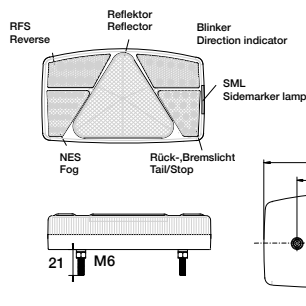

Blinklicht
Direction indicator

Rücklicht
Tail light

Bremslicht
Stop light

Nebelschlusslicht
Fog light

Rückfahrlicht
Reverse light

Dreieckrückstrahler
Triangle reflector

BEST. NR						ZUSATZFUNKTION	ANSCHLUSS		
PART NO						SPECIAL FUNCTION	CONNECTOR	mm	
41-1310-011	1/28	●			10-30	Seitenmarkierungslicht Sidemarker light	offenes Ende open end	0,50 m	21
41-1310-121	1/28		●		10-30	Seitenmarkierungslicht Sidemarker light	offenes Ende open end	0,50 m	21
41-1310-041	1/28	●			10-30		offenes Ende open end	0,50 m	21
41-1310-151	1/28		●		10-30		offenes Ende open end	0,50 m	21



ECOFAB

ADR Zone 2 LED IP6K9K E

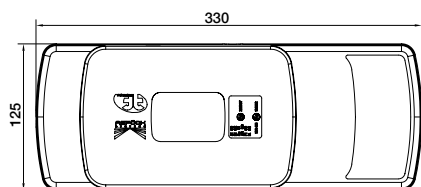

HORIZONTAL / VERTICAL

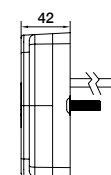
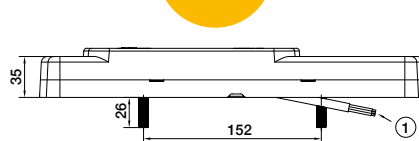
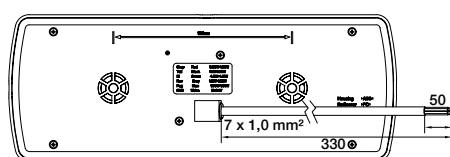

Blinklicht Direction indicator	Rücklicht Tail light	Bremslicht Stop light	Nebelschlusslicht Fog light
Rückfahrlicht Reverse light		Rückstrahler rot Reflector red	

BEST. NR PART NO		←	→	⚡ V	ZUSATZFUNKTION SPECIAL FUNCTION	ANSCHLUSS CONNECTOR
41-2010-001	1/20	●	●	10-30		offenes Ende open end 0,30 m
41-2010-011	1/20	●		10-30		7 pol. ASS2 männlich 7 pin ASS2 male 0,30 m ♂
41-2010-021	1/20		●	10-30		7 pol. ASS2 männlich 7 pin ASS2 male 0,30 m ♂

RoundFAB

ROUND FAB

ADR Zone 2

LED

IP 6K9K

E

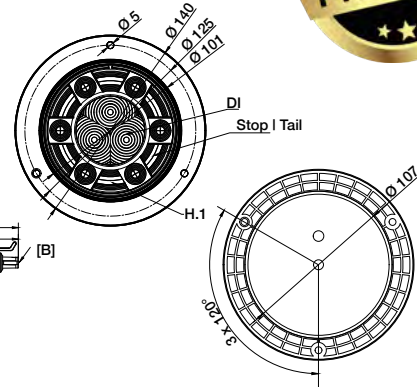
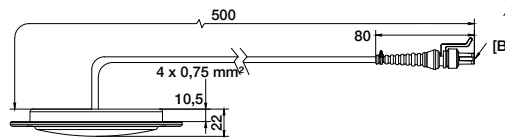
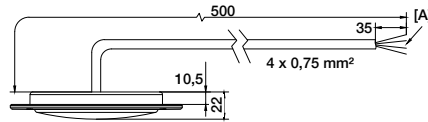

Blinklicht
Direction indicator



Rücklicht
Tail light



Bremslicht
Stop light

BEST. NR PART NO	📦	←	→		⚡ V	ANSCHLUSS		🔧 mm
						CONNECTOR		
41-2000-001	1/100	●	●	[A]	10-30	offenes Ende open end	0,50 m	🔗 -
41-2000-011	1/100	●	●	[B]	10-30	4 pol. Superseal weiblich 4 pin Superseal female	0,50 m	♀ 19 🔌 -

LED IP 67 E



HECKLEUCHE / REAR LAMP

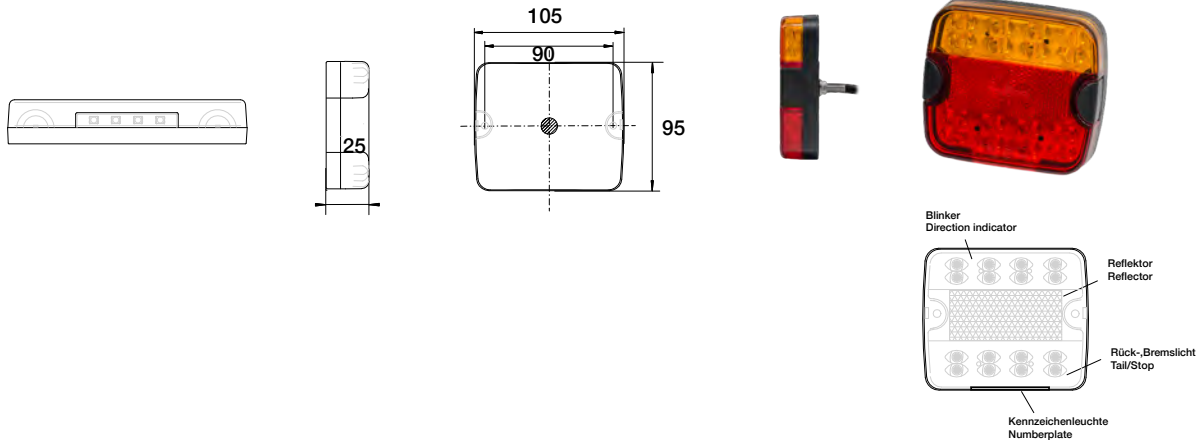

BEST. NR		Beschreibung	←	→			ANSCHLUSS		
PART NO		Description					CONNECTOR		mm
41-1331-001	1/50	<ul style="list-style-type: none"> Rücklicht Tail light Bremslicht Stop light Blinklicht Direction indicator Rückstrahler rot Reflector red 	●	●	●	9-33	offenes Ende open end	0,50 m	11

41-138

HECKLEUCHE / REAR LAMP

E LED IP 65

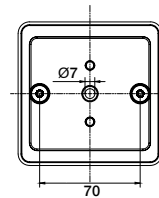
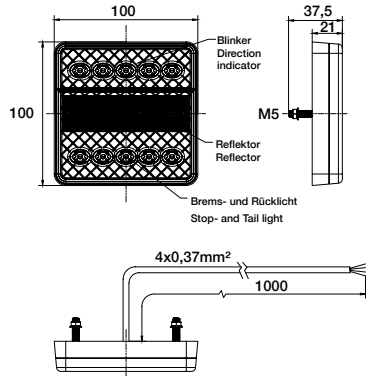

Blinklicht
Direction indicator



Rücklicht
Tail light



Bremslicht
Stop light



Rückstrahler rot
Reflector red

BEST. NR						ZUSATZFUNKTION	ANSCHLUSS	
PART NO						SPECIAL FUNCTION	CONNECTOR	mm
41-1384-011	1/-	●	●		12		offenes Ende open end	1,00 m



E LED IP 65

HECKLEUCHE / REAR LAMP

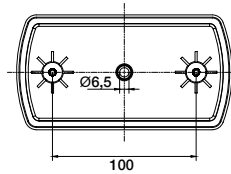
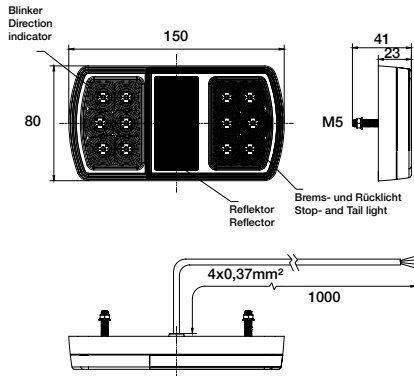

Blinklicht
Direction indicator



Rücklicht
Tail light



Bremslicht
Stop light



Rückstrahler rot
Reflector red

BEST. NR						ZUSATZFUNKTION	ANSCHLUSS	
PART NO						SPECIAL FUNCTION	CONNECTOR	mm
41-1394-011	1/-	●	●		12		offenes Ende open end	1,00 m

MiniFAB

MINIFAB

ADR Zone 2

ISO 13766-2

LED

IP 6K9K

E

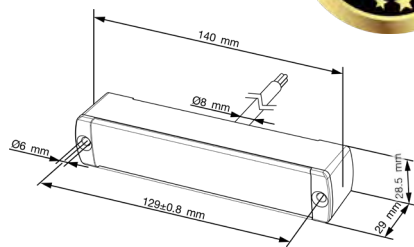

BEST. NR		BEZEICHNUNG	⚡ V	C°	↕	←	→	ANSCHLUSS	
PART NO		DESCRIPTION						CONNECTOR	
41-2030-001	1/50	Blinklicht Direction indicator Rücklicht Tail light Bremslicht Stop light	9 - 30	-40 ~ +50	●	●	●	A	offenes Ende open end 0,5m
41-2031-001	1/50	Rückfahrlicht Reverse light Nebelschlusslicht Fog light	9 - 30	-40 ~ +50	●	●	●	B	offenes Ende open end 0,5m
41-2032-001	1/50	Nebelschlusslicht Fog light	9 - 30	-40 ~ +50	●	●	●	C	offenes Ende open end 0,5m
41-2033-001	1/50	Rückfahrlicht Reverse light	9 - 30	-40 ~ +50	●	●	●	D	offenes Ende open end 0,5m

HECKLEUCHE / REAR LAMP

LED IP 67 E

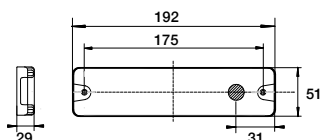
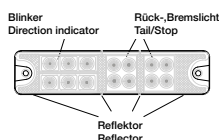

BEST. NR PART NO		BEZEICHNUNG DESCRIPTION	←	→			ANSCHLUSS CONNECTOR	
41-1321-001	1/50	<ul style="list-style-type: none"> Rücklicht Tail light Bremslicht Stop light Blinklicht Direction indicator Rückstrahler rot Reflector red 	●	●		10-30	offenes Ende open end 0,30 m	17

41-140

CHROMRING / CHROME RING

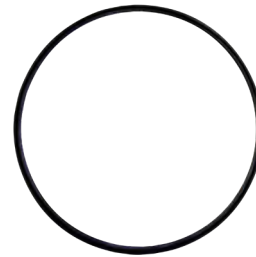

Passend für 3 Kammerleuchte, d = 140 mm
Fits for 3 chamber lamp, d = 140 mm

BEST. NR		Beschreibung
PART NO		Description
41-1400-004	1/40	Chromring für 3 Kammerleuchte, d = 140 mm Chrome ring for 3 chamber lamp, d = 140 mm

BATTERY WORKING LAMP LED 1000 F

LED CE

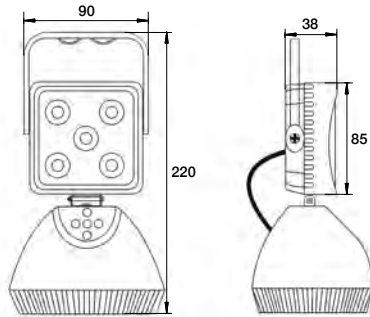

BEST. NR PART NO		ARBEITSSCHEINWERFER WORKING LAMP	LUMEN	WATT	ZUSATZFUNKTION SPECIAL FUNCTION
42-1000-251	1/-	 30% 13h 100% 4h	1000	15	4 Stufen (Leistung Farbe): 100 % weiß 100 % orange Energiesparmodus 30 % weiß SOS Licht orange mit Akku 4 modes (Power Colour): 100 % white 100 % amber ECO 30 % white SOS Flash in amber with rechargeable battery

WORKING LAMP LED 3500 F

E R10 LED IP 67 EMC

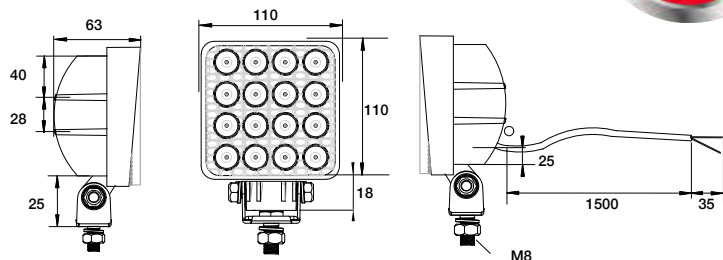

BEST. NR PART NO		ARBEITSSCHEINWERFER WORKING LAMP		C°	LUMEN	WATT	ANSCHLUSS CONNECTOR
42-1003-001	1/20		10 - 30	-40 ~ +50	3500	36	offenes Ende open end 1,50 m

42-100

E R10 **E R23** **LED** **IP 67** **EMC**



WORKING & REVERSE LAMP LED 1200 F

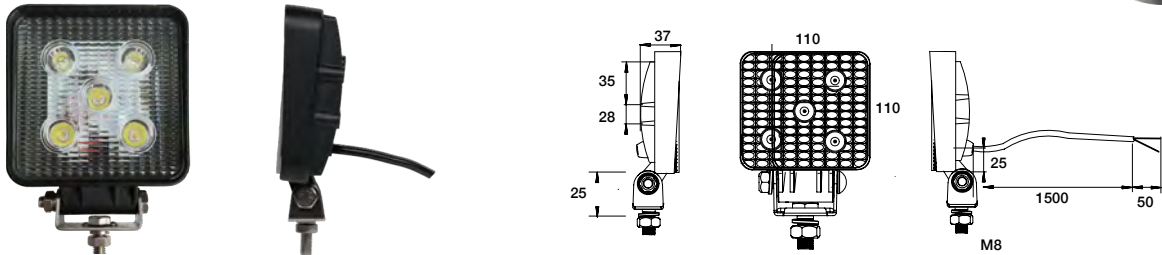

BEST. NR PART NO		ARBEITSSCHEINWERFER WORKING LAMP	V	C°	LUMEN	WATT	ANSCHLUSS CONNECTOR
42-1000-001	1/20		10 - 30	-40 ~ +50	1200	15	offenes Ende open end 1,50 m

E R10 **E R23** **LED** **IP 67** **EMC**



WORKING & REVERSE LAMP LED 2000 F

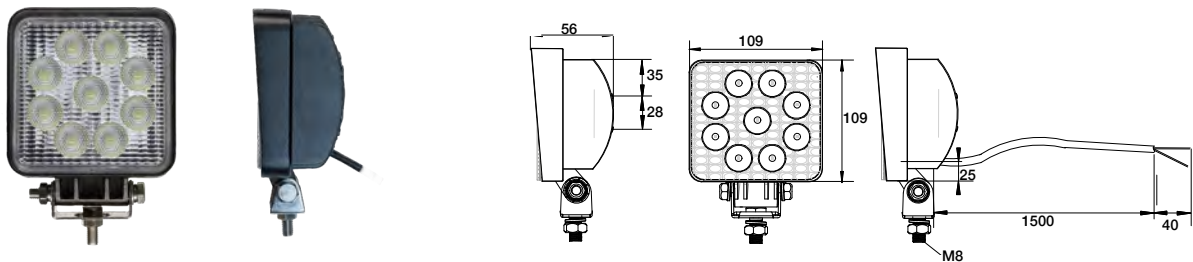

BEST. NR PART NO		ARBEITSSCHEINWERFER WORKING LAMP	V	C°	LUMEN	WATT	ANSCHLUSS CONNECTOR
42-1001-001	1/20		10 - 30	-40 ~ +50	2000	27	offenes Ende open end 1,50 m

WORKING LAMP LED 1200 F

E R10 LED IP 67 EMC

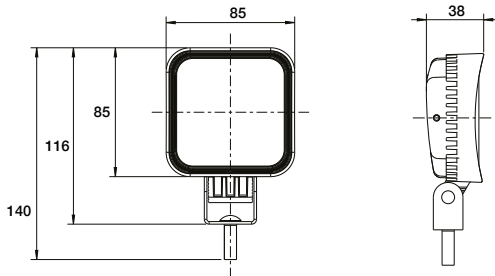

BEST. NR	WORKING LAMP	ARBEITSSCHEINWERFER	⚡	C°	LUMEN	WATT	ANSCHLUSS	CONNECTOR
42-1000-101	1/20		10 - 30	-40 ~ +50	1200	15	offenes Ende open end	1,50 m ↪

WORKING LAMP LED 1800 F

E R10 E R23 LED IP 67 EMC

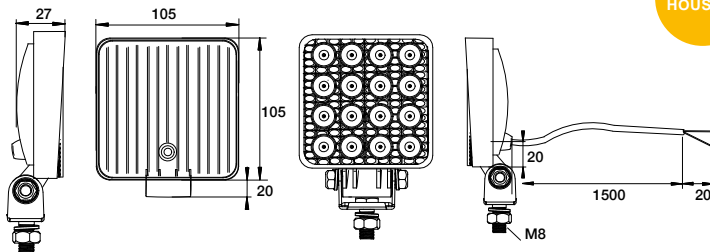

PLASTIC HOUSING



BEST. NR	WORKING LAMP	ARBEITSSCHEINWERFER	⚡	C°	LUMEN	WATT	ANSCHLUSS	CONNECTOR
42-1006-001	1/20	plastic housing 	10 - 30	-40 ~ +50	1800	12	offenes Ende open end	1,50 m ↪

42-100

WORKING LAMP LED 1300 F

E R10 **LED** **IP 67** **EMC**

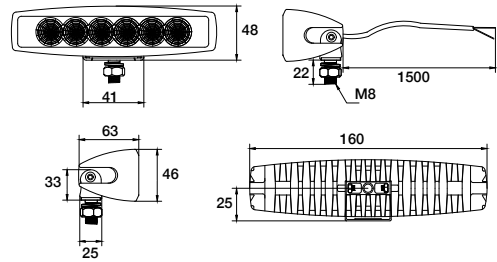

BEST. NR		ARBEITSSCHEINWERFER	V	C°	LUMEN	WATT	ANSCHLUSS	
PART NO		WORKING LAMP					CONNECTOR	
42-1008-401	1/20		10 - 30	-40 ~ +50	1300	13	offenes Ende open end	1,50 m

WORKING LAMP LED 2000 F

E R10 **LED** **IP 67** **EMC**

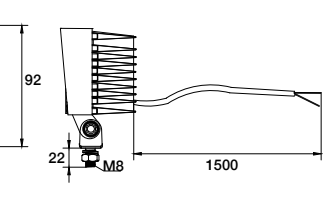
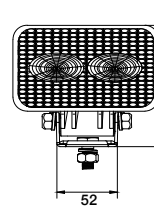
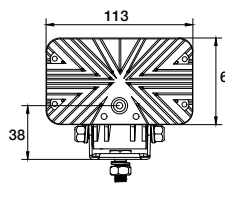
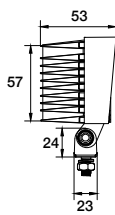

BEST. NR		ARBEITSSCHEINWERFER	V	C°	LUMEN	WATT	ANSCHLUSS	
PART NO		WORKING LAMP					CONNECTOR	
42-1008-301	1/20		10 - 30	-40 ~ +50	2000	18	offenes Ende open end	1,50 m

WORKING LAMP LED 1800

E_{R10} **LED** **IP 67** **EMC**

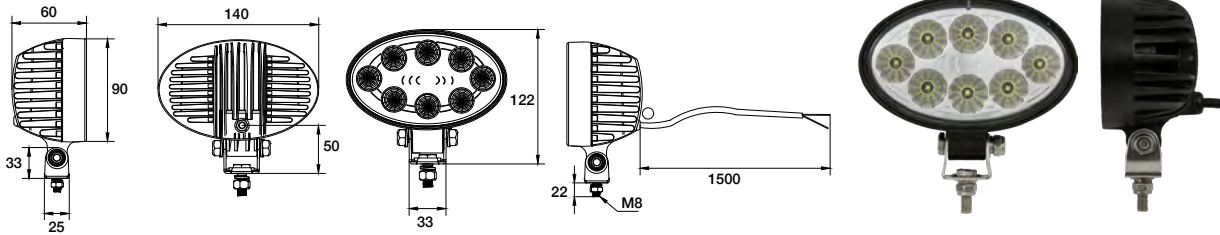

BEST. NR	ARBEITSSCHEINWERFER	⚡ V	C°	LUMEN	WATT	ANSCHLUSS	
PART NO	WORKING LAMP					CONNECTOR	
42-1007-001	1/20 FLOOD	10 - 30	-40 ~ +50	1800	16	offenes Ende open end	1,50 m

WORKING LAMP LED 2000 S

E_{R10} **LED** **IP 67** **EMC**

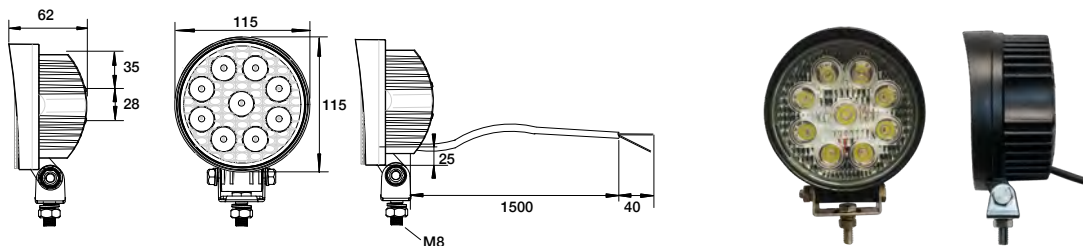

BEST. NR	ARBEITSSCHEINWERFER	⚡ V	C°	LUMEN	WATT	ANSCHLUSS	
PART NO	WORKING LAMP					CONNECTOR	
42-1002-001	1/20 SPOT	10 - 30	-40 ~ +50	2000	22	offenes Ende open end	1,50 m

42-100

E_{R10} **E_{R23}** **LED** **IP 67** **EMC**



WORKING & REVERSE LAMP LED 900 F

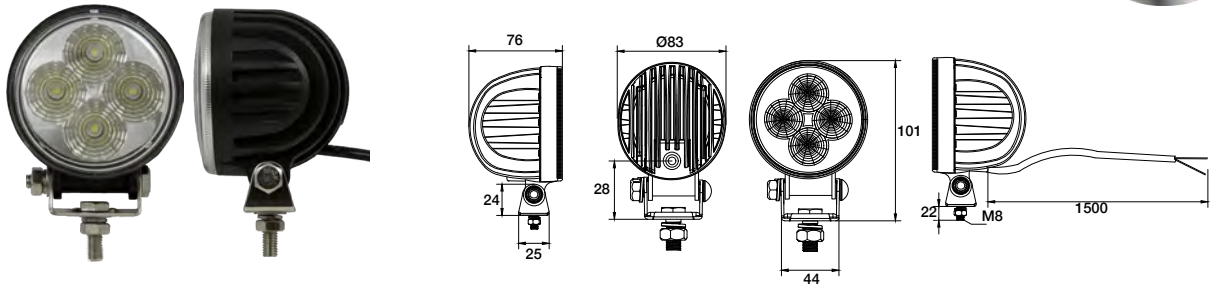

BEST. NR		ARBEITS- & RÜCKFAHRSCHINWERFER	V	C°	LUMEN	WATT	ANSCHLUSS
PART NO		WORKING & REVERSE LAMP					CONNECTOR
42-1008-001	1/20		10 - 30	-40 ~ +50	900	10	offenes Ende open end 1,50 m

E_{R10} **LED** **IP 67** **EMC**



WORKING LAMP LED 800 F / S

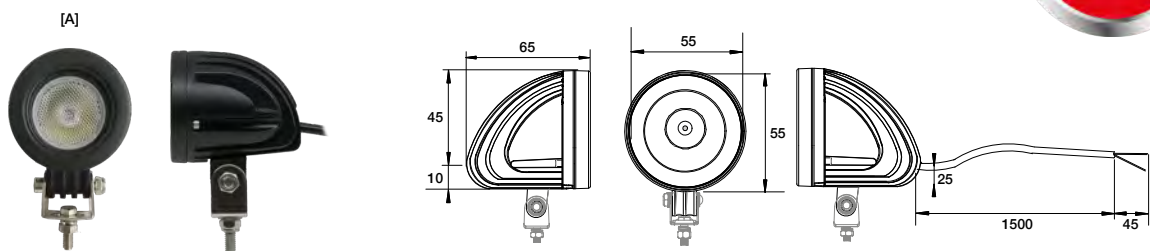

BEST. NR		ARBEITSSCHINWERFER	V	C°	LUMEN	WATT	ANSCHLUSS
PART NO		WORKING LAMP					CONNECTOR
42-1004-001	1/20	[A]	10 - 30	-40 ~ +50	800	10	offenes Ende open end 1,50 m



ADR Zone 2 E R10 E R23 LED IP69K EMC

WORKFAB I 1600 WITH SWITCH

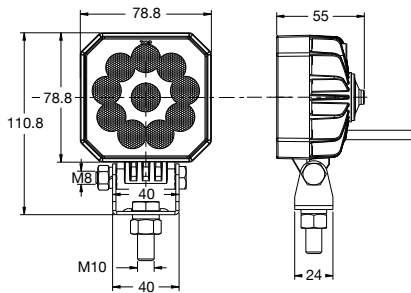

BEST. NR PART NO		ARBEITSSSCHEINWERFER WORKING LAMP	⚡	C°	LUMEN		WATT	ANSCHLUSS CONNECTOR	
					RAW	EFF.			
42-1009-001	1/20		9 - 59	-45 ~ +60	1600	1113	10	offenes Ende open end	1,50 m

ADR Zone 2 E R10 E R23 LED IP69K EMC

WORKFAB I 1600

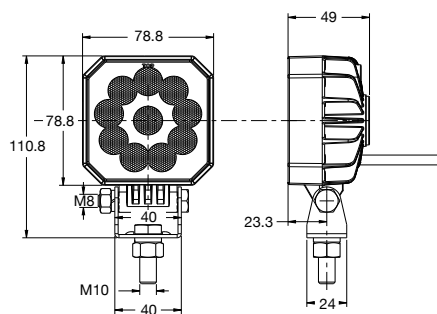

BEST. NR PART NO		ARBEITSSSCHEINWERFER WORKING LAMP	⚡	C°	LUMEN		WATT	ANSCHLUSS CONNECTOR	
					RAW	EFF.			
42-1009-011	1/20		9 - 59	-45 ~ +60	1600	1113	10	offenes Ende open end	1,50 m
42-1009-401			9 - 59	-45 ~ +60	1600	1113	10	offenes Ende open end	5,00 m
42-1009-501			9 - 59	-45 ~ +60	1600	1113	10	offenes Ende open end	13,00 m

WorkFAB II



WORKFAB II 4500

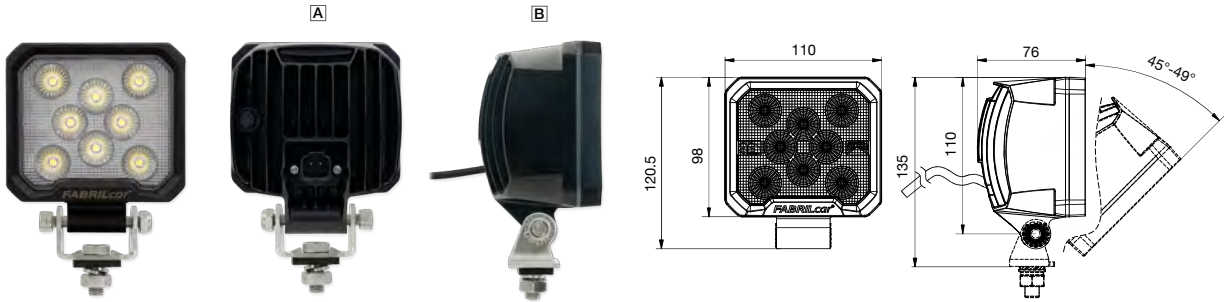

BEST. NR PART NO		GEHÄUSE HOUSING		C°	CISPR25 KLASSE CLASS	ISO	LUMEN		WATT	ANSCHLUSS CONNECTOR		
							RAW	EFF				
42-1011-311	1/12	Aluminium	9 - 59	-40 - +50	B	3	4500	3306	34	offenes Ende open end	1,50 m	
<i>verfügbar Q2/2023 available Q2/2023</i>												
42-1021-311	1/12	Aluminium	9 - 59	-40 - +50	B	5	13766:2	4500	3306	34	offenes Ende open end	1,50 m
42-1011-301	1/12	Aluminium	9 - 59	-40 - +50	A	3	4500	3306	34	Deutsch Verbinder Deutsch Connector	Zubehör inkludiert Accessoires included 	
<i>verfügbar Q2/2023 available Q2/2023</i>												
42-1021-301	1/12	Aluminium	9 - 59	-40 - +50	A	5	13766:2	4500	3306	34	Deutsch Verbinder Deutsch Connector	Zubehör inkludiert Accessoires included



ADR Zone 2 CE UK CA LED IP6K9K

WORKFAB II 3500

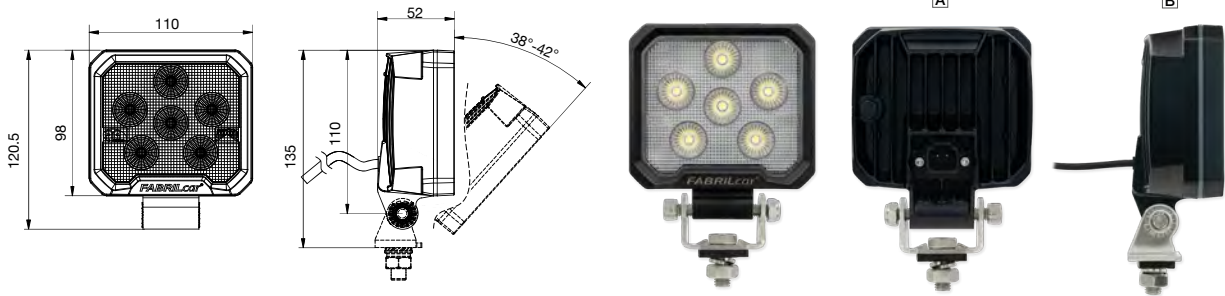

BEST. NR PART NO		GEHÄUSE HOUSING		C°		CISPR25 KLASSE CLASS	ISO	LUMEN		WATT	ANSCHLUSS CONNECTOR	
								RAW	EFF			
42-1011-211	1/12	Aluminium	9 - 59	-40 - +50	B	3		3500	2211	23	offenes Ende open end	1,50 m
<i>verfügbar Q2/2023 available Q2/2023</i>												
42-1021-211	1/12	Aluminium	9 - 59	-40 - +50	B	5	13766:2	3500	2211	23	offenes Ende open end	1,50 m
42-1011-201	1/12	Aluminium	9 - 59	-40 - +50	A	3		3500	2211	23	Deutsch Verbinder Deutsch Connector	Zubehör inkludiert Accessoires included
<i>verfügbar Q2/2023 available Q2/2023</i>												
42-1021-201	1/12	Aluminium	9 - 59	-40 - +50	A	5	13766:2	3500	2211	23	Deutsch Verbinder Deutsch Connector	Zubehör inkludiert Accessoires included

WorkFAB II



WORKFAB II 3000

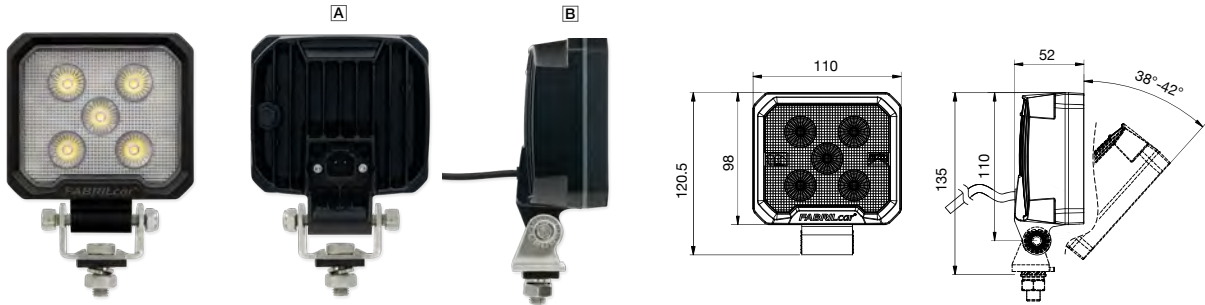

BEST. NR PART NO		GEHÄUSE HOUSING		C°		CISPR25 KLASSE CLASS	ISO	LUMEN		WATT	ANSCHLUSS CONNECTOR
								RAW	EFF		
42-1011-111	1/12	Aluminium	9 - 59	-40 - +50	B	3		3000	1745	19	offenes Ende open end 1,50 m
<i>verfügbar Q2/2023 available Q2/2023</i>											
42-1021-111	1/12	Aluminium	9 - 59	-40 - +50	B	5	13766:2	3000	1745	19	offenes Ende open end 1,50 m
42-1011-101	1/12	Aluminium	9 - 59	-40 - +50	A	3		3000	1745	19	Deutsch Verbinder Deutsch Connector Zubehör inkludiert Accessoires included
<i>verfügbar Q2/2023 available Q2/2023</i>											
42-1021-101	1/12	Aluminium	9 - 59	-40 - +50	A	5	13766:2	3000	1745	19	Deutsch Verbinder Deutsch Connector Zubehör inkludiert Accessoires included



ADR Zone 2 CE UK CR FLOOD LED IP6K9K E AR148 E R10

WORKFAB II 2500



BEST. NR PART NO		GEHÄUSE HOUSING		C°	CISPR25 KLASSE CLASS	ISO	LUMEN		WATT	ANSCHLUSS CONNECTOR		
							RAW	EFF				
42-1010-111	1/12	Kunststoff Plastic	9 - 59	-40 - +50	B	3	2500	1643	16	offenes Ende open end	1,50 m	
<i>verfügbar Q2/2023 available Q2/2023</i>												
42-1020-111	1/12	Kunststoff Plastic	9 - 59	-40 - +50	B	5	13766:2	2500	1643	16	offenes Ende open end	1,50 m
42-1010-101	1/12	Kunststoff Plastic	9 - 59	-40 - +50	A	3		2500	1643	16	Deutsch Verbinder Deutsch Connector Zubehör inkludiert Accessoires included	
<i>verfügbar Q2/2023 available Q2/2023</i>												
42-1020-101	1/12	Kunststoff Plastic	9 - 59	-40 - +50	A	5	13766:2	2500	1643	16	Deutsch Verbinder Deutsch Connector Zubehör inkludiert Accessoires included	

WorkFAB II



WORKFAB II 2000

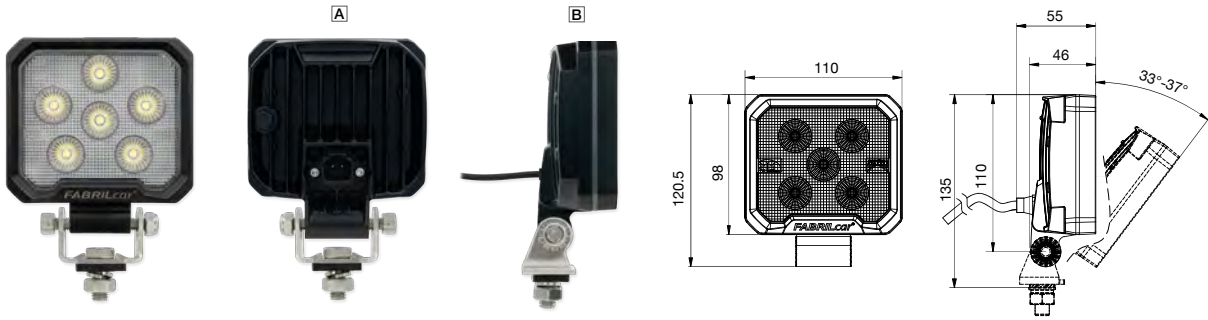

BEST. NR PART NO		GEHÄUSE HOUSING		C°		CISPR25 KLASSE CLASS	ISO	LUMEN		WATT	ANSCHLUSS CONNECTOR	
								RAW	EFF			
42-1011-011	1/12	Aluminium	9 - 59	-40 - +50	B	3		2000	1181	16	offenes Ende open end	1,50 m
<i>verfügbar Q2/2023 available Q2/2023</i>												
42-1021-011	1/12	Aluminium	9 - 59	-40 - +50	B	5	13766:2	2000	1181	16	offenes Ende open end	1,50 m
42-1011-001	1/12	Aluminium	9 - 59	-40 - +50	A	3		2000	1181	16	Deutsch Verbinder Deutsch Connector	Zubehör inkludiert Accessoires included
<i>verfügbar Q2/2023 available Q2/2023</i>												
42-1021-001	1/12	Aluminium	9 - 59	-40 - +50	A	5	13766:2	2000	1181	16	Deutsch Verbinder Deutsch Connector	Zubehör inkludiert Accessoires included



WORKFAB II 1500

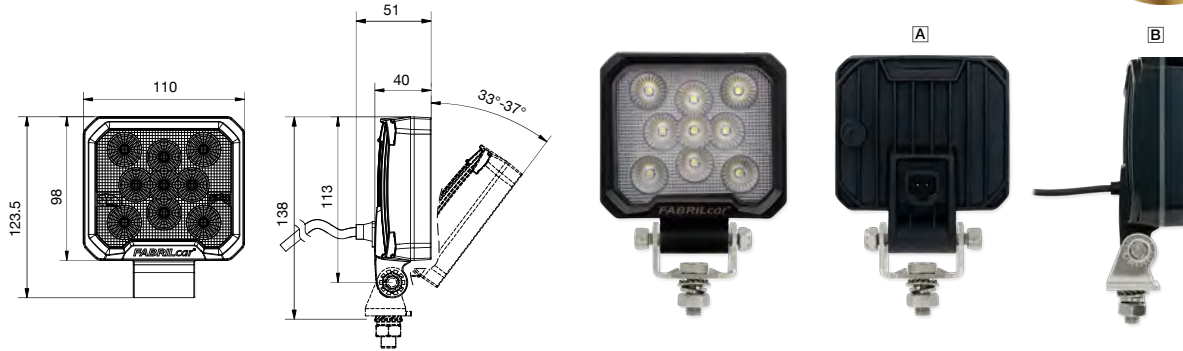

BEST. NR PART NO		GEHÄUSE HOUSING		C°		CISPR25 KLASSE CLASS	ISO	LUMEN		WATT	ANSCHLUSS CONNECTOR	
								RAW	EFF			
42-1010-011	1/12	Kunststoff Plastic	9 - 59	-40 - +50	B	3		1500	903	16	offenes Ende open end	1,50 m
<i>verfügbar Q2/2023 available Q2/2023</i>												
42-1020-011	1/12	Kunststoff Plastic	9 - 59	-40 - +50	B	5	13766:2	1500	903	16	offenes Ende open end	1,50 m
42-1010-001	1/12	Kunststoff Plastic	9 - 59	-40 - +50	A	3		1500	903	16	Deutsch Verbinder Deutsch Connector	Zubehör inkludiert Accessoires included
<i>verfügbar Q2/2023 available Q2/2023</i>												
42-1020-001	1/12	Kunststoff Plastic	9 - 59	-40 - +50	A	5	13766:2	1500	903	16	Deutsch Verbinder Deutsch Connector	Zubehör inkludiert Accessoires included

MoveFAB



MOVEFAB

verfügbar Q2/2023
available Q2/2023

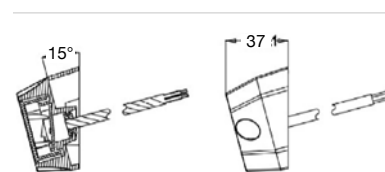
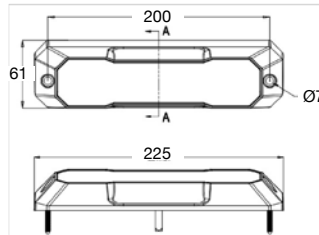

BEST. NR		GEHÄUSE					ZUSATZFUNKTION	ANSCHLUSS
PART NO		HOUSING	CISPR25 KLASSE CLASS		C°	WATT	SPECIAL FUNCTION	CONNECTOR
42-2001-001	1/20	Kunststoff Plastic	3	9 - 30	-40 ~ +50°C	7	Spezielle AR 148 Manövrierrückfahrer Zulassung Special AR 148 manoeuvring light homologation	offenes Ende open end 0,5m



SCENEFAB

verfügbar Q2/2023
available Q2/2023

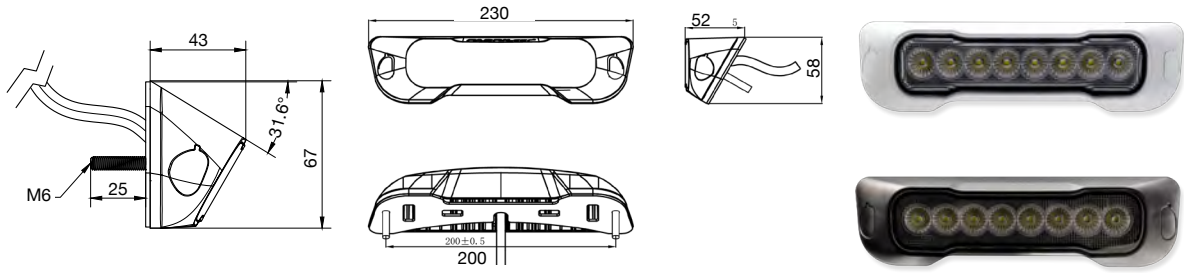

BEST. NR	GEHÄUSE	GEHÄUSE					FARBE	LUMEN		ANSCHLUSS	
PART NO		HOUSING	CISPR25 KLASSE CLASS	⚡	°	WATT	COLOUR	RAW	EFF	CONNECTOR	
42-2000-001	1/15	Aluminium	3	9 - 30	-40 ~ +50	18	weißes Gehäuse white housing	2400	1613	offenes Ende open end	0,5m
42-2000-501	1/15	Aluminium	3	9 - 30	-40 ~ +50	18	schwarzes Gehäuse black housing	2400	1613	offenes Ende open end	0,5m

42-300

E



POSITIONSLEUCHE - SEITENMARKIERUNGSLUCHE POSITION LAMP - SIDE MARKER LAMP

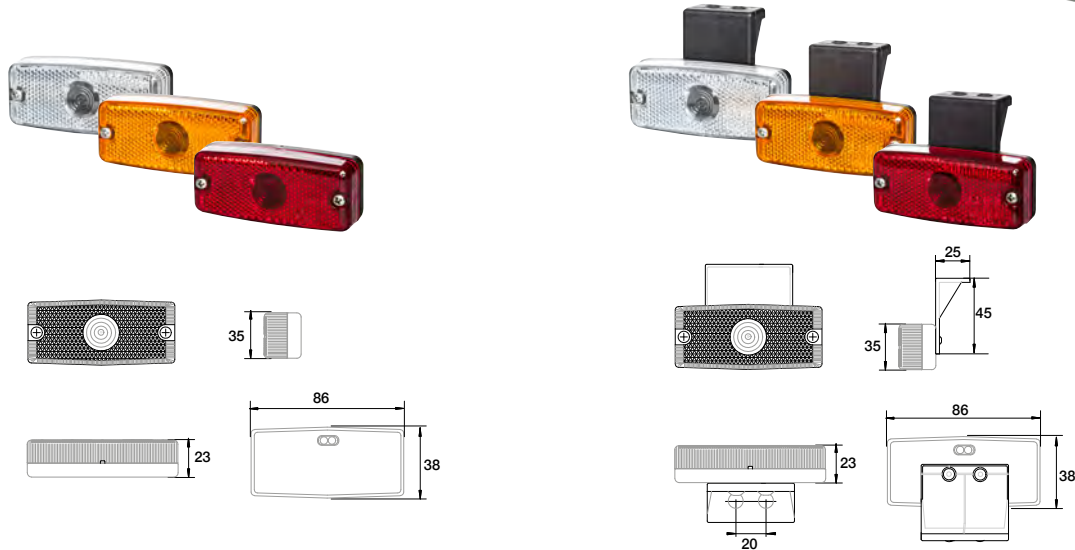

BEST. NR		BEZEICHNUNG		FARBE	WINKEL	ANSCHLUSS	ABBILDUNG
PART NO		DESCRIPTION		COLOUR	BRACKET	CONNECTOR	PICTURE
42-3000-004	1/250	Positionslicht vorne Front position light	Rückstrahler weiß Reflector white	weiß white		Tülle grommet	
42-3000-104	1/125	Positionslicht vorne Front position light	Rückstrahler weiß Reflector white	weiß white	● 90°	Tülle grommet	
42-3001-004	1/250	Seitenmarkierungslicht Sidemarker light	Rückstrahler gelb Reflector amber	gelb amber		Tülle grommet	
42-3001-104	1/125	Seitenmarkierungslicht Sidemarker light	Rückstrahler gelb Reflector amber	gelb amber	● 90°	Tülle grommet	
42-3002-004	1/250	Positionslicht hinten Rear position light	Rückstrahler rot Reflector red	rot red		Tülle grommet	
42-3002-104	1/125	Positionslicht hinten Rear position light	Rückstrahler rot Reflector red	rot red	● 90°	Tülle grommet	

Positionsleuchte - Seitenmarkierungsleuchte Position lamp - Side marker lamp



UniFAB



ADR Zone 2 LED IP6K9K EMC E

UNIFAB

HORIZONTAL / VERTICAL

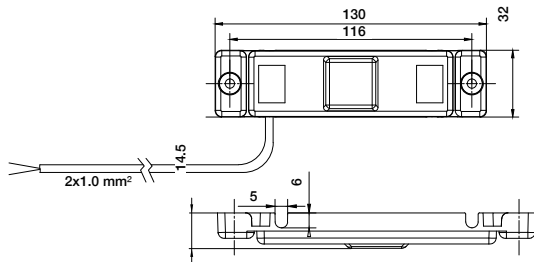

BEST. NR		BEZEICHNUNG	FARBE	⚡ V	ANSCHLUSS	
PART NO		DESCRIPTION	COLOUR		CONNECTOR	
42-3474-001	1/-	Seitenmarkierungslicht Sidemarker light Rückstrahler gelb Reflector amber	gelb amber	10-30	offenes Ende open end	0,50 m
42-3474-041	1/-	Seitenmarkierungslicht Sidemarker light Rückstrahler gelb Reflector amber	gelb amber	10-30	P&R Kabel P&R cable	0,50 m
42-3474-051	1/-	Seitenmarkierungslicht Sidemarker light Rückstrahler gelb Reflector amber	gelb amber	10-30	P&R Kabel P&R cable	1,50 m
42-3474-061	1/-	Seitenmarkierungslicht Sidemarker light Rückstrahler gelb Reflector amber	gelb amber	10-30	P&R Kabel P&R cable	5,00 m

UniFAB

ADR
Zone 2

LED

IP6K9K

EMC

E



UNIFAB



HORIZONTAL /
VERTICAL

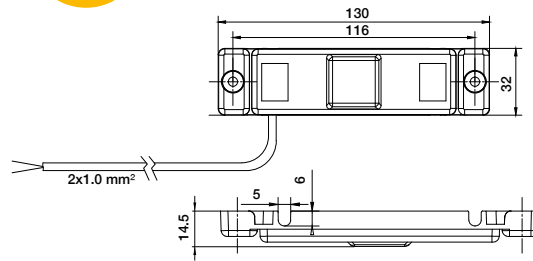

BEST. NR	BEZEICHNUNG	FARBE	ANSCHLUSS
PART NO	DESCRIPTION	COLOUR	CONNECTOR
42-3474-101	Positionslicht vorne Front position light Rückstrahler weiß Reflector white	weiß white	10-30 offenes Ende open end
42-3474-141	Positionslicht vorne Front position light Rückstrahler weiß Reflector white	weiß white	10-30 P&R Kabel P&R cable
42-3474-151	Positionslicht vorne Front position light Rückstrahler weiß Reflector white	weiß white	10-30 P&R Kabel P&R cable
42-3474-161	Positionslicht vorne Front position light Rückstrahler weiß Reflector white	weiß white	10-30 P&R Kabel P&R cable
42-3474-171	Positionslicht vorne Front position light Rückstrahler weiß Reflector white	weiß white	10-30 P&R Kabel P&R cable
42-3474-201	Positionslicht hinten Rear position light Rückstrahler rot Reflector red	rot red	10-30 offenes Ende open end
42-3474-241	Positionslicht hinten Rear position light Rückstrahler rot Reflector red	rot red	10-30 P&R Kabel P&R cable
42-3474-251	Positionslicht hinten Rear position light Rückstrahler rot Reflector red	rot red	10-30 P&R Kabel P&R cable
42-3474-261	Positionslicht hinten Rear position light Rückstrahler rot Reflector red	rot red	10-30 P&R Kabel P&R cable
42-3474-271	Positionslicht hinten Rear position light Rückstrahler rot Reflector red	rot red	10-30 P&R Kabel P&R cable

42-400



LED IP 67 E

UMRISSLEUCHE END OUTLINE MARKER LAMP

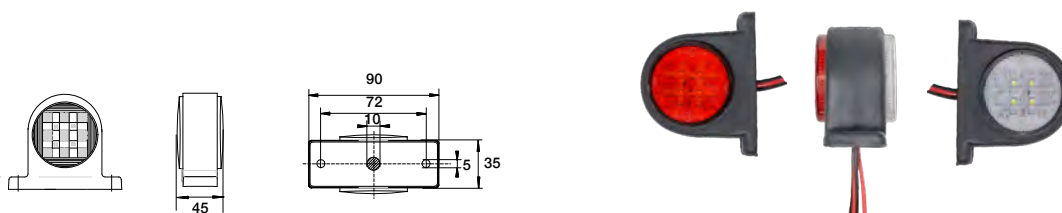

BEST. NR		BESCHREIBUNG	←	→			ANSCHLUSS		
PART NO		DESCRIPTION					CONNECTOR		mm
42-4000-001	1/50	Umrissleuchte End outline marker lamp	●	●		10-30	offenes Ende open end	0,20 m	10

TA1 LED IP6K9K ADR Zone 2 E R10 E R65



STROBEFAB I SLIM

verfügbar Q2/2023
available Q2/2023

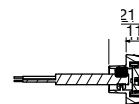
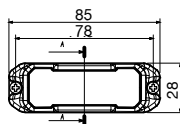
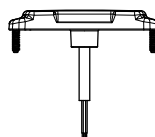

BEST. NR						°C	CISPR25 KLASSE CLASS	ZUSATZFUNKTION SPECIAL FUNCTION	ANSCHLUSS CONNECTOR
PART NO									
42-4055-001	1/20	●	●	●	9 - 30	-40 ~ +50	3	gelb amber Synchronisation von bis zu 8 Leuchten oder Wechselbetrieb Synchronisation up to 8 lamps or alternating mode 10 verschiedene Blinkmuster 10 different flash patterns	offenes Ende open end 1,50 m
42-4055-011	1/20	●	●	●	9 - 30	-40 ~ +50	3	blau blue Synchronisation von bis zu 8 Leuchten oder Wechselbetrieb Synchronisation up to 8 lamps or alternating mode 10 verschiedene Blink- muster 10 different flash patterns	offenes Ende open end 1,50 m

TA1

LED

IP6K9K

ADR Zone 2

E R10

E R65



STROBEFAB I STANDARD

verfügbar Q2/2023
available Q2/2023

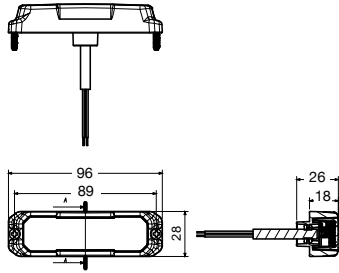

BEST. NR						C°	CISPR25 KLASSE CLASS	ZUSATZFUNKTION	ANSCHLUSS
PART NO								SPECIAL FUNCTION	CONNECTOR
42-4055-301	1/20	●	●	●	9 - 30	-40 ~ +50	3	gelb amber Synchronisation von bis zu 8 Leuchten oder Wechselbetrieb Synchronisation up to 8 lamps or alternating mode 10 verschiedene Blinkmuster 10 different flash patterns	offenes Ende open end 1,50 m
42-4055-311	1/20	●	●	●	9 - 30	-40 ~ +50	3	blau blue Synchronisation von bis zu 8 Leuchten oder Wechselbetrieb Synchronisation up to 8 lamps or alternating mode 10 verschiedene Blinkmuster 10 different flash patterns	offenes Ende open end 1,50 m

TA1 LED IP 6K9K ADR Zone 2 E R10 E R65



STROBEFAB I BUILT IN

verfügbar Q2/2023
available Q2/2023

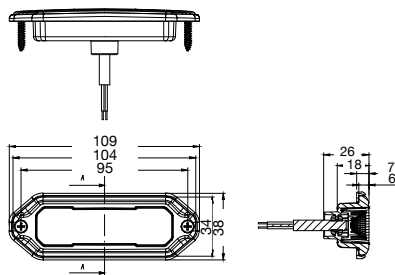

BEST. NR						C°	CISPR25 KLASSE CLASS	ZUSATZFUNKTION	ANSCHLUSS
PART NO								SPECIAL FUNCTION	CONNECTOR
42-4055-601	1/20	●	●	●	9 - 30	-40 ~ +50	3	gelb amber Synchronisation von bis zu 8 Leuchten oder Wechselbetrieb Synchronisation up to 8 lamps or alternating mode 10 verschiedene Blinkmuster 10 different flash patterns	offenes Ende open end 1,50 m
42-4055-611	1/20	●	●	●	9 - 30	-40 ~ +50	3	blau blue Synchronisation von bis zu 8 Leuchten oder Wechselbetrieb Synchronisation up to 8 lamps or alternating mode 10 verschiedene Blinkmuster 10 different flash patterns	offenes Ende open end 1,50 m



TA1 LED IP6K9K ADR Zone 2 E R10 E R65

STROBEFAB II SLIM

verfügbar Q2/2023
available Q2/2023

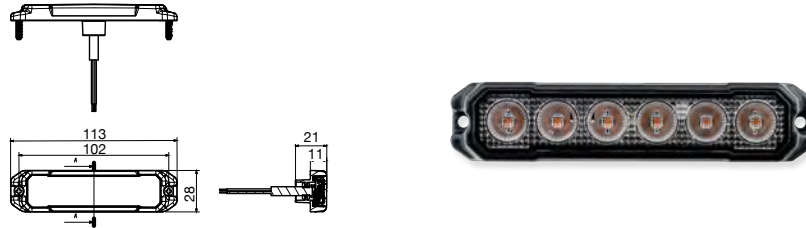

BEST. NR						C°	CISPR25 KLASSE CLASS	ZUSATZFUNKTION	ANSCHLUSS
PART NO								SPECIAL FUNCTION	CONNECTOR
42-4056-001	1/20	●	●	●	9 - 30	-40 ~ +50	3	gelb amber Synchronisation von bis zu 8 Leuchten oder Wechselbetrieb Synchronisation up to 8 lamps or alternating mode 10 verschiedene Blinkmuster 10 different flash patterns	offenes Ende open end 1,50 m
42-4056-011	1/20	●	●	●	9 - 30	-40 ~ +50	3	blau blue Synchronisation von bis zu 8 Leuchten oder Wechselbetrieb Synchronisation up to 8 lamps or alternating mode 10 verschiedene Blinkmuster 10 different flash patterns	offenes Ende open end 1,50 m
42-4056-031	1/20	●	●	●	9 - 30	-40 ~ +50	3	rot red Synchronisation von bis zu 8 Leuchten oder Wechselbetrieb Synchronisation up to 8 lamps or alternating mode 10 verschiedene Blink- muster 10 different flash patterns	offenes Ende open end 1,50 m

StrobeFAB II

TA2 TA1 LED IP6K9K ADR Zone 2 E R10 E R65



STROBEFAB II STANDARD

verfügbar Q2/2023
available Q2/2023

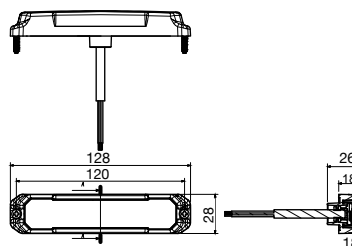

BEST. NR						°C	CISPR25 KLASSE CLASS	ZUSATZFUNKTION	ANSCHLUSS
PART NO								SPECIAL FUNCTION	CONNECTOR
42-4056-301	1/20	●	●	●	9 - 30	-40 ~ +50	5	gelb amber Synchronisation von bis zu 8 Leuchten oder Wechselbetrieb Synchronisation up to 8 lamps or alternating mode 10 verschiedene Blinkmuster 10 different flash patterns	offenes Ende open end 1,50 m
42-4056-311	1/20	●	●	●	9 - 30	-40 ~ +50	5	blau blue Synchronisation von bis zu 8 Leuchten oder Wechselbetrieb Synchronisation up to 8 lamps or alternating mode 10 verschiedene Blinkmuster 10 different flash patterns	offenes Ende open end 1,50 m
42-4056-321	1/20	●	●	●	9 - 30	-40 ~ +50	5	gelb & blau amber & blue Synchronisation von bis zu 8 Leuchten oder Wechselbetrieb Synchronisation up to 8 lamps or alternating mode 10 verschiedene Blinkmuster 10 different flash patterns	offenes Ende open end 1,50 m



STROBEFAB II STANDARD

verfügbar Q2/2023
available Q2/2023

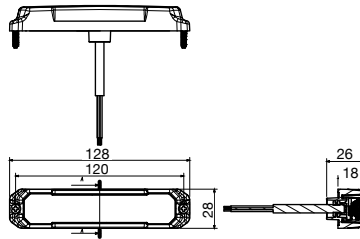

TA2 TA1 LED IP6K9K ADR Zone 2 E R10 E R65

BEST. NR						°C	CISPR25 KLASSE CLASS	ZUSATZFUNKTION	ANSCHLUSS
PART NO								SPECIAL FUNCTION	CONNECTOR
42-4056-331	1/20	●	●	●	9 - 30	-40 ~ +50	5	rot red Synchronisation von bis zu 8 Leuchten oder Wechselbetrieb Synchronisation up to 8 lamps or alternating mode 10 verschiedene Blinkmuster 10 different flash patterns	offenes Ende open end 1,50 m



STROBEFAB II STANDARD

verfügbar Q2/2023
available Q2/2023

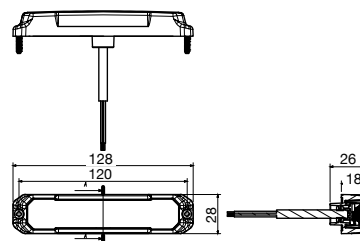

TA1 LED IP6K9K ADR Zone 2 E R10 E R65

BEST. NR						°C	CISPR25 KLASSE CLASS	ZUSATZFUNKTION	ANSCHLUSS
PART NO								SPECIAL FUNCTION	CONNECTOR
42-4056-351	1/20	●	●	●	9 - 30	-40 ~ +50	5	weiß white Synchronisation von bis zu 8 Leuchten oder Wechselbetrieb Synchronisation up to 8 lamps or alternating mode 10 verschiedene Blinkmuster 10 different flash patterns	offenes Ende open end 1,50 m

StrobeFAB II

TA2 TA1 LED IP6K9K ADR Zone 2 E R10 E R65



STROBEFAB II BUILT IN

verfügbar Q2/2023
available Q2/2023

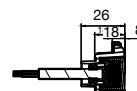
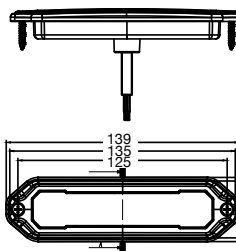

BEST. NR						C°	CISPR25 KLASSE CLASS	ZUSATZFUNKTION	ANSCHLUSS
PART NO								SPECIAL FUNCTION	CONNECTOR
42-4056-601	1/20	●	●	●	9 - 30	-40 ~ +50	5	gelb amber Synchronisation von bis zu 8 Leuchten oder Wechselbetrieb Synchronisation up to 8 lamps or alternating mode 10 verschiedene Blinkmuster 10 different flash patterns	offenes Ende open end 1,50 m
42-4056-611	1/20	●	●	●	9 - 30	-40 ~ +50	5	blau blue Synchronisation von bis zu 8 Leuchten oder Wechselbetrieb Synchronisation up to 8 lamps or alternating mode 10 verschiedene Blinkmuster 10 different flash patterns	offenes Ende open end 1,50 m
42-4056-621	1/20	●	●	●	9 - 30	-40 ~ +50	5	gelb & blau amber & blue Synchronisation von bis zu 8 Leuchten oder Wechselbetrieb Synchronisation up to 8 lamps or alternating mode 10 verschiedene Blinkmuster 10 different flash patterns	offenes Ende open end 1,50 m

TA2 TA1 LED IP6K9K ADR Zone 2 E R10 E R65



STROBEFAB II BUILT IN

verfügbar Q2/2023
available Q2/2023

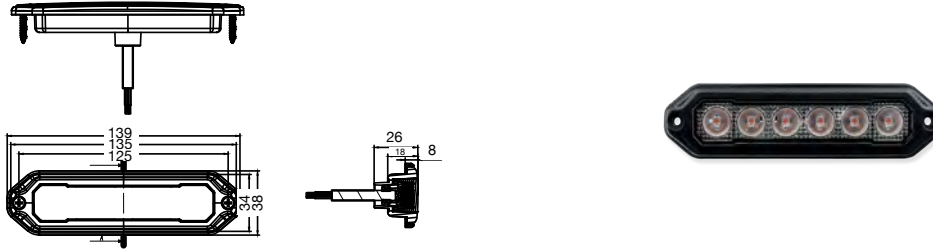

BEST. NR						C°	CISPR25 KLASSE CLASS	ZUSATZFUNKTION	ANSCHLUSS
PART NO								SPECIAL FUNCTION	CONNECTOR
42-4056-631	1/20	●	●	●	9 - 30	-40 ~ +50	5	rot red Synchronisation von bis zu 8 Leuchten oder Wechselbetrieb Synchronisation up to 8 lamps or alternating mode 10 verschiedene Blinkmuster 10 different flash patterns	offenes Ende open end 1,50 m
42-4056-651	1/20	●	●	●	9 - 30	-40 ~ +50	5	weiß white Synchronisation von bis zu 8 Leuchten oder Wechselbetrieb Synchronisation up to 8 lamps or alternating mode 10 verschiedene Blinkmuster 10 different flash patterns	offenes Ende open end 1,50 m

StrobeFAB III

TA1 LED IP6K9K ADR Zone 2 E R10 E R65



STROBEFAB III SLIM

verfügbar Q2/2023
available Q2/2023

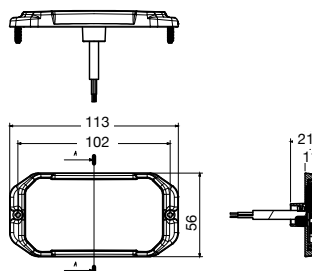

BEST. NR						C°	CISPR25 KLASSE CLASS	ZUSATZFUNKTION	ANSCHLUSS
PART NO								SPECIAL FUNCTION	CONNECTOR
42-4057-001	1/20	●	●	●	9 - 30	-40 ~ +50	3	gelb amber GELB AMBER Synchronisation von bis zu 8 Leuchten oder Wechselbetrieb Synchronisation up to 8 lamps or alternating mode 10 verschiedene Blinkmuster 10 different flash patterns	offenes Ende open end 1,50 m
42-4057-011	1/20	●	●	●	9 - 30	-40 ~ +50	3	blau blue BLAU BLUE Synchronisation von bis zu 8 Leuchten oder Wechselbetrieb Synchronisation up to 8 lamps or alternating mode 10 verschiedene Blinkmuster 10 different flash patterns	offenes Ende open end 1,50 m

TA2 TA1 LED IP6K9K ADR Zone 2 E R10 E R65



STROBEFAB III STANDARD

verfügbar Q2/2023
available Q2/2023

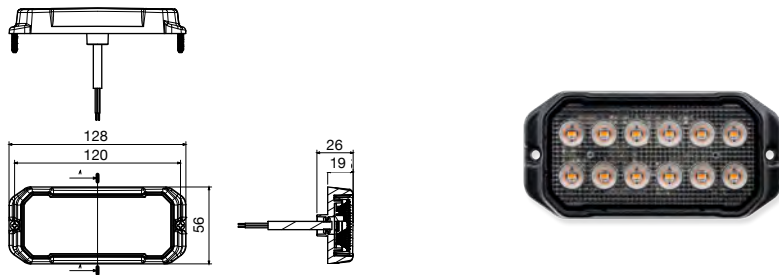

BEST. NR						C°	CISPR25 KLASSE CLASS	ZUSATZFUNKTION	ANSCHLUSS
PART NO								SPECIAL FUNCTION	CONNECTOR
42-4057-301	1/20	●	●	●	9 - 30	-40 ~ +50	5	gelb amber Synchronisation von bis zu 8 Leuchten oder Wechselbetrieb Synchronisation up to 8 lamps or alternating mode 10 verschiedene Blinkmuster 10 different flash patterns	offenes Ende open end 1,50 m
42-4057-311	1/20	●	●	●	9 - 30	-40 ~ +50	5	blau blue Synchronisation von bis zu 8 Leuchten oder Wechselbetrieb Synchronisation up to 8 lamps or alternating mode 10 verschiedene Blinkmuster 10 different flash patterns	offenes Ende open end 1,50 m

StrobeFAB III

TA2 TA1 LED IP6K9K ADR Zone 2 E R10 E R65



STROBEFAB III BUILT IN

verfügbar Q2/2023
available Q2/2023

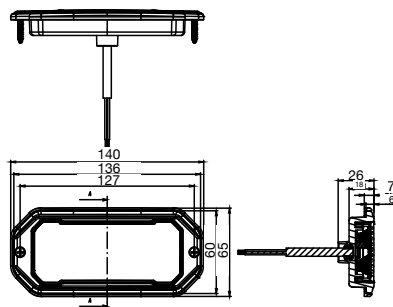

BEST. NR						C°	CISPR25 KLASSE CLASS	ZUSATZFUNKTION	ANSCHLUSS
PART NO								SPECIAL FUNCTION	CONNECTOR
42-4057-601	1/20	●	●	●	9 - 30	-40 ~ +50	5	gelb amber Synchronisation von bis zu 8 Leuchten oder Wechselbetrieb Synchronisation up to 8 lamps or alterna- tating mode 10 verschiedene Blinkmuster 10 different flash patterns	offenes Ende open end 1,50 m
42-4057-611	1/20	●	●	●	9 - 30	-40 ~ +50	5	blau blue Synchronisation von bis zu 8 Leuchten oder Wechselbetrieb Synchronisation up to 8 lamps or alterna- tating mode 10 verschiedene Blinkmuster 10 different flash patterns	offenes Ende open end 1,50 m

TA2 TA1 LED IP6K9K ADR Zone 2 E R10 E R65



STROBEFAB IV SQUARE

verfügbar Q2/2023
available Q2/2023

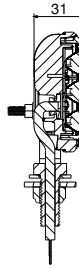
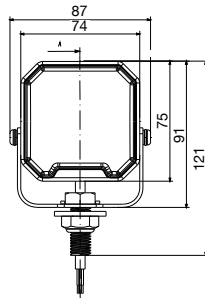
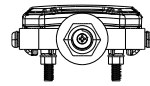

BEST. NR						°C	CISPR25 KLASSE CLASS	ZUSATZFUNKTION	ANSCHLUSS
PART NO								SPECIAL FUNCTION	CONNECTOR
42-4058-001	1/20	●	●	●	9 - 30	-40 ~ +50	5	gelb amber Synchronisation von bis zu 8 Leuchten oder Wechselbetrieb Synchronisation up to 8 lamps or alternating mode 10 verschiedene Blinkmuster 10 different flash patterns	offenes Ende open end 1,50 m } ←
42-4058-011	1/20	●	●	●	9 - 30	-40 ~ +50	5	blau blue Synchronisation von bis zu 8 Leuchten oder Wechselbetrieb Synchronisation up to 8 lamps or alternating mode 10 verschiedene Blink- muster 10 different flash patterns	offenes Ende open end 1,50 m } ←

42-405

STROBE LAMP

E_{R10} LED IP 67 EMC

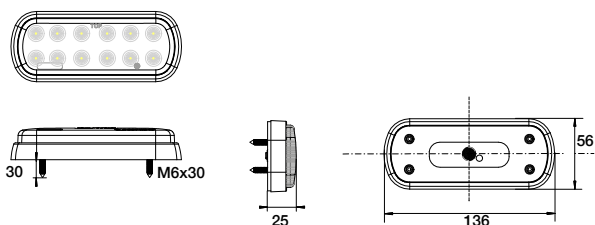

BEST. NR PART NO		←	→		°C	ZUSATZFUNKTION SPECIAL FUNCTION	ANSCHLUSS CONNECTOR	
42-4050-001	1/50	●	●	10-30	-30 ~ +60°C	gelb amber Synchron- oder Wechselbetrieb synchronous- or alternating operation 18 verschiedene Blinkmuster 18 different flash patterns	offenes Ende open end 0,25 m	10

STROBE LAMP

E_{R65} E_{R10} LED IP 67 EMC

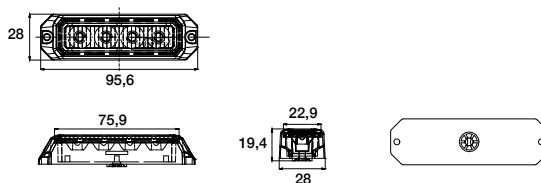

BEST. NR PART NO		←	→		°C	ZUSATZFUNKTION SPECIAL FUNCTION	ANSCHLUSS CONNECTOR	
42-4054-001	1/-	●	●	10-30	-30 ~ +60°C	gelb amber Synchron- oder Wechselbetrieb synchronous- or alternating operation 26 verschiedene Blinkmuster 26 different flash patterns	offenes Ende open end 1,50 m	10

STROBE LAMP

ER65 **E**R10 LED IP 67 EMC

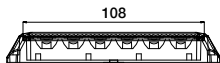
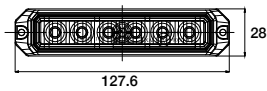

BEST. NR		←	→		°C	ZUSATZFUNKTION	ANSCHLUSS		
PART NO						SPECIAL FUNCTION	CONNECTOR	mm	
42-4054-011	1/-	●	●	10-30	-30 ~ +60°C	gelb amber	offenes Ende open end	1,50 m	10
						Synchron- oder Wechselbetrieb synchronous- or alternating operation			
						26 verschiedene Blinkmuster 26 different flash patterns			

STROBE LAMP

ER10 LED IP 67 EMC

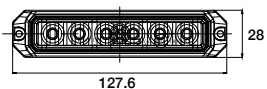

BEST. NR		←	→		°C	ZUSATZFUNKTION	ANSCHLUSS		
PART NO						SPECIAL FUNCTION	CONNECTOR	mm	
42-4054-051	1/-	●	●	10-30	-30 ~ +60°C	weiß white	offenes Ende open end	1,50 m	10
						Synchron- oder Wechselbetrieb synchronous- or alternating operation			
						26 verschiedene Blinkmuster 26 different flash patterns			

42-405

STROBE LAMP

E_{R10} LED IP 67 EMC

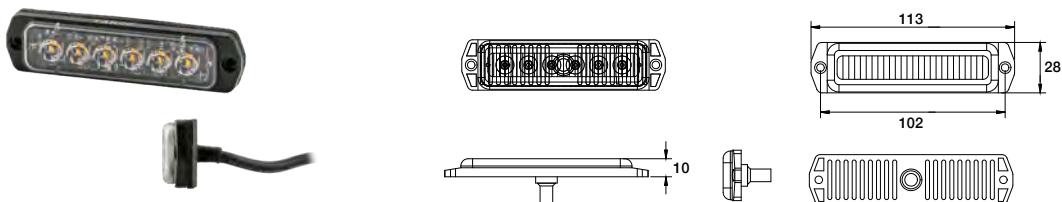

BEST. NR PART NO		←	→		C°	ZUSATZFUNKTION SPECIAL FUNCTION	ANSCHLUSS CONNECTOR	
42-4054-021	1/-	●	●	10-30	-30 ~ +60°C	gelb amber Synchron- oder Wechselbetrieb synchronous- or alternating operation 26 verschiedene Blinkmuster 26 different flash patterns	offenes Ende open end 1,50 m	10

STROBE LAMP

E_{R65} E_{R10} LED IP 67 EMC

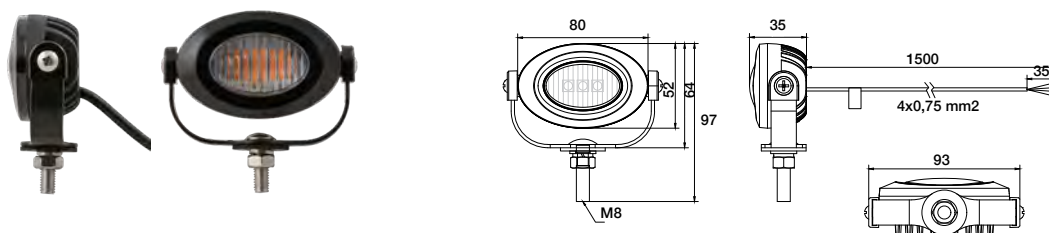

BEST. NR PART NO		←	→		C°	ZUSATZFUNKTION SPECIAL FUNCTION	ANSCHLUSS CONNECTOR	
42-4054-061	1/20	●	●	10-30	-30 ~ +60°C	gelb amber Synchron- oder Wechselbetrieb synchronous- or alternating operation 23 verschiedene Blinkmuster 23 different flash patterns	offenes Ende open end 1,50 m	10

STROBE LAMP

E R65 E R10 LED IP 67 EMC

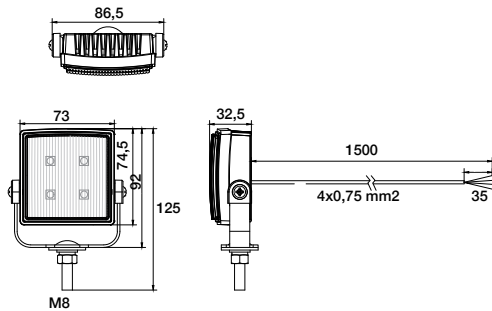

BEST. NR PART NO		←	→	⚡ V	°C	ZUSATZFUNKTION SPECIAL FUNCTION	ANSCHLUSS CONNECTOR		mm
42-4054-071	1/20	●	●	10-30	-30 ~ +60°C	gelb amber Synchron- oder Wechselbetrieb synchronous- or alternating operation 23 verschiedene Blinkmuster 23 different flash patterns	offenes Ende open end 1,50 m		10

STROBE LAMP

E R65 E R10 LED IP 67 EMC

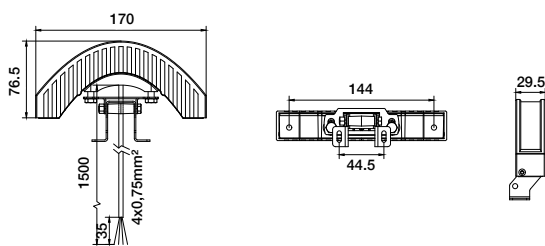

BEST. NR PART NO		←	→	⚡ V	°C	ZUSATZFUNKTION SPECIAL FUNCTION	ANSCHLUSS CONNECTOR		mm
42-4054-081	1/20	●	●	10-30	-30 ~ +60°C	gelb amber Synchron- oder Wechselbetrieb synchronous- or alternating operation 26 verschiedene Blinkmuster 26 different flash patterns	offenes Ende open end 1,50 m		10

FLASHFAB FLAT

ADR Zone 2 * E R65 E R10 LED IP 67 EMC

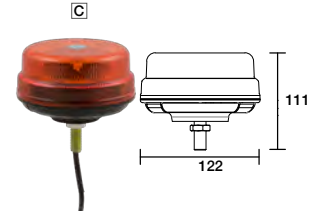
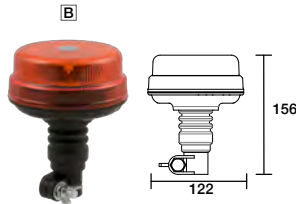
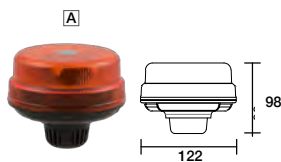

* ER65 nur bei Rotation
* ER65 only by rotation

BEST. NR			C°	WATT	ZUSATZFUNKTION	ANSCHLUSS
PART NO					SPECIAL FUNCTION	CONNECTOR
42-4404-011	1/20	9 - 30	-30~ +50	14	A 4 verschiedene Blinkmuster (*Rotation, Einzelblitz, Doppelblitz, Schnellblitz) 4 different flash patterns (*rotation, single flash, double flash, quick flash)	DIN Anschluss DIN connector
42-4404-031	1/20	9 - 30	-30~ +50	14	B 4 verschiedene Blinkmuster (*Rotation, Einzelblitz, Doppelblitz, Schnellblitz) 4 different flash patterns (*rotation, single flash, double flash, quick flash)	flexibler DIN Anschluss flexible DIN connector
42-4404-041	1/20	9 - 30	-30~ +50	14	C Synchronbetrieb 4 verschiedene Blinkmuster (*Rotation, Einzelblitz, Doppelblitz, Schnellblitz) synchronous operation 4 different flash patterns (*rotation, single flash, double flash, quick flash)	Schraubanschluss offenes Ende 0,30 m single bolt fixation open end



FLASHFAB FLAT

ADR Zone 2 * E R65 E R10 LED IP 67 EMC

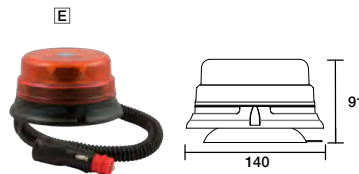
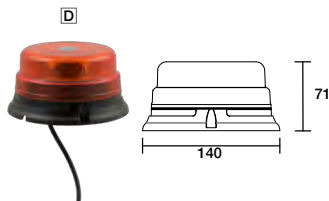

* ER65 nur bei Rotation
* ER65 only by rotation

BEST. NR			°C	WATT	ZUSATZFUNKTION	ANSCHLUSS
PART NO					SPECIAL FUNCTION	CONNECTOR
42-4404-051	1/20	9 - 30	-30~ +50	14	Synchronbetrieb 4 verschiedene Blinkmuster (*Rotation, Einzelblitz, Doppelblitz, Schnellblitz)	3 Punktbefestigung offenes Ende 0,30 m
					synchronous operation 4 different flash patterns (*rotation, single flash, double flash, quick flash)	3 bolt fixation open end
42-4404-061	1/20	9 - 30	-30~ +50	14	4 verschiedene Blinkmuster (*Rotation, Einzelblitz, Doppelblitz, Schnellblitz)	3 Punktbefestigung magnetisch Stecker DIN 4165 4 m
					4 different flash patterns (*rotation, single flash, double flash, quick flash)	3 bolt fixation magnetic plug DIN 4165

FLASHFAB DEEP

ADR Zone 2

* E R65

E R10

LED

IP 67

EMC

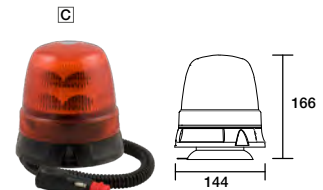
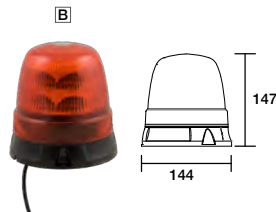
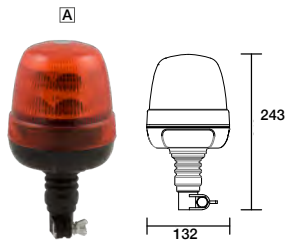

* ER65 nur bei Rotation
* ER65 only by rotation

BEST. NR			C°	WATT	ZUSATZFUNKTION	ANSCHLUSS
PART NO					SPECIAL FUNCTION	CONNECTOR
42-4404-131	1/20	9 - 30	-30~ +50	13	A 4 verschiedene Blinkmuster (*Rotation, Einzelblitz, Doppelblitz, Schnellblitz) 4 different flash patterns (*rotation, single flash, double flash, quick flash)	flexibler DIN Anschluss
42-4404-151	1/20	9 - 30	-30~ +50	13	B Synchronbetrieb 4 verschiedene Blinkmuster (*Rotation, Einzelblitz, Doppelblitz, Schnellblitz) synchronous operation 4 different flash patterns (*rotation, single flash, double flash, quick flash)	3 Punktbefestigung offenes Ende 0,30 m 3 bolt fixation open end
42-4404-161	1/20	9 - 30	-30~ +50	13	C 4 verschiedene Blinkmuster (*Rotation, Einzelblitz, Doppelblitz, Schnellblitz) 4 different flash patterns (*rotation, single flash, double flash, quick flash)	3 Punktbefestigung magnetisch Stecker DIN 4165 4 m 3 bolt fixation magnetic plug DIN 4165



FLASHFAB HALOGEN

ADR Zone 2 * E R65 E R10 Halogen IP 67 EMC

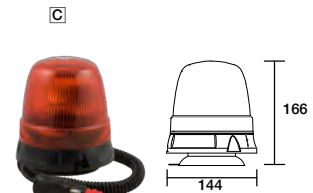
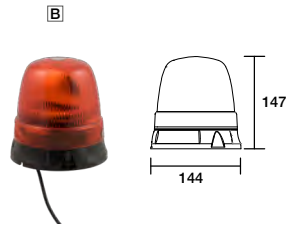
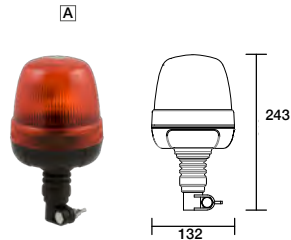

* ER65 nur bei Rotation
* ER65 only by rotation

BEST. NR				C°	WATT	ANSCHLUSS
PART NO						CONNECTOR
42-4404-231	1/20	+ Halogen 12V + Halogen 24V	12V 24V	-30~ +50	12V (H1) 55 WATT 24V (H1) 70 WATT	A flexibler DIN Anschluss flexible DIN connector
42-4404-251	1/20	+ Halogen 12V + Halogen 24V	12V 24V	-30~ +50	12V (H1) 55 WATT 24V (H1) 70 WATT	B 3 Punktbefestigung 3 bolt fixation
42-4404-261	1/20	+ Halogen 12V + Halogen 24V	12V 24V	-30~ +50	12V (H1) 55 WATT 24V (H1) 70 WATT	C 3 Punktbefestigung Stecker DIN 4165 4 m 3 bolt fixation plug DIN 4165

42-450

RUNDUMLEUCHE BEACON

E R10 **LED** **IP 66** **EMC**

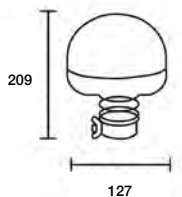

BEST. NR			C°	WATT	ZUSATZFUNKTION	ANSCHLUSS
PART NO					SPECIAL FUNCTION	CONNECTOR
42-4504-001	1/20	9 - 30	-30~ +50	8	3 verschiedene Blinkmuster (Rotation, Einzelblitz, Schnellblitz) 3 different flash patterns (rotation, single flash, quick flash)	flexibler DIN Anschluss flexible DIN connector

BATTERIE-RUNDUMLEUCHE BATTERY BEACON

E R10 **LED** **IP 66** **EMC**

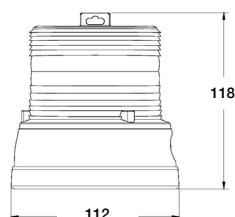

BEST. NR		C°	ZUSATZFUNKTION	BEFESTIGUNG
PART NO			SPECIAL FUNCTION	ATTACHMENT
42-4505-001	1/20	-30~ +60	4 x 1,5V AA Batterien (nicht enthalten) 4 x 1,5V AA batteries (not included) Betriebsdauer ca. 260-300 Stunden operation time about 260-300 hours 2 verschiedene Blinkmuster (Rotation, Einzelblitz) 2 different flash patterns (rotation, single flash) Mit Lichtsensor with light sensor	magnetisch magnetic



HALTERUNG FÜR RUNDUMLEUCHE BRACKET FOR BEACON

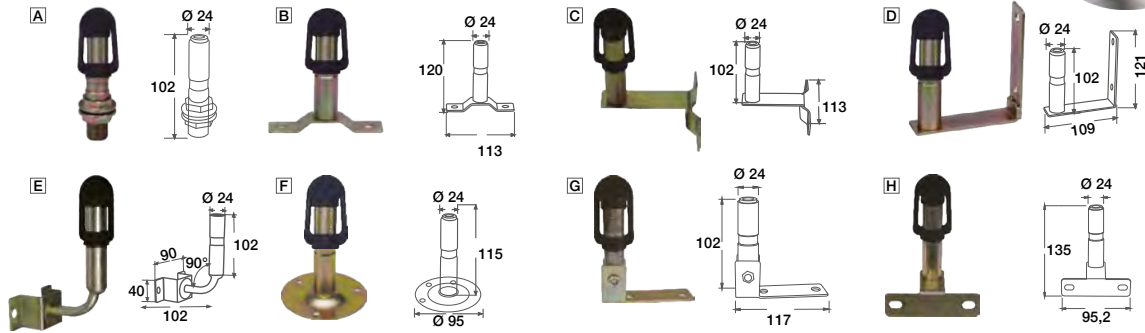

BEST. NR		DIN	ABBILDUNG
PART NO			PICTURE
42-4417-001	1/1	DIN72591	
42-4417-011	1/1	DIN72591	
42-4417-021	1/1	DIN72591	
42-4417-031	1/1	DIN72591	
42-4417-041	1/1	DIN72591	
42-4417-051	1/1	DIN72591	
42-4417-061	1/1	DIN72591	
42-4417-071	1/1	DIN72591	

42-406

LEUCHTBALKEN LIGHT BAR

E R65 **E** R10 LED IP 65 EMC

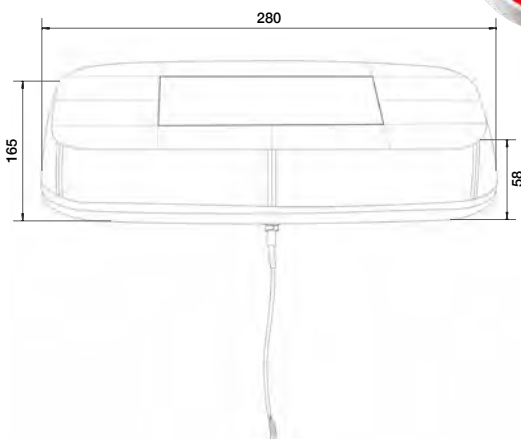

BEST. NR PART NO			C°	ZUSATZFUNKTION SPECIAL FUNCTION	ANSCHLUSS CONNECTOR
42-4060-101	1/12	9 - 30	-30~ +60	gelb amber 8 verschiedene Blitzmuster 8 different flash patterns	Schraubanschluss offenes Ende single bolt fixation open end 0,40 m

LEUCHTBALKEN LIGHT BAR

E R65 **E** R10 LED IP 65 EMC

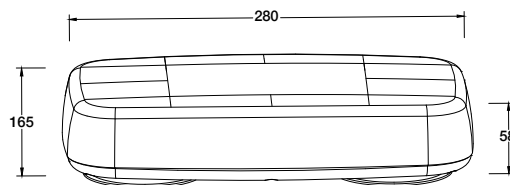
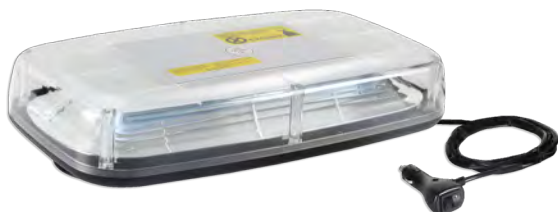

BEST. NR PART NO			C°	ZUSATZFUNKTION SPECIAL FUNCTION	ANSCHLUSS CONNECTOR
42-4060-111	1/12	9 - 30	-30~ +60	gelb amber 8 verschiedene Blitzmuster 8 different flash patterns	magnetisch Stecker DIN 4165 magnetic plug DIN 4165 3,00 m

42-410

E



KENNZEICHENLEUCHE NUMBER PLATE LAMP

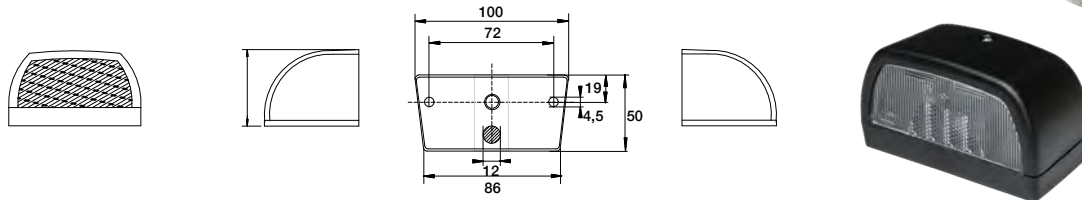

BEST. NR		BEZEICHNUNG	←	→			ANSCHLUSS		mm	
PART NO		DESCRIPTION					CONNECTOR			
42-4100-001	1/114	Kennzeichenleuchte Number plate light	●	●	●	12-24	Tülle grommet			12

E



KENNZEICHENLEUCHE NUMBER PLATE LAMP

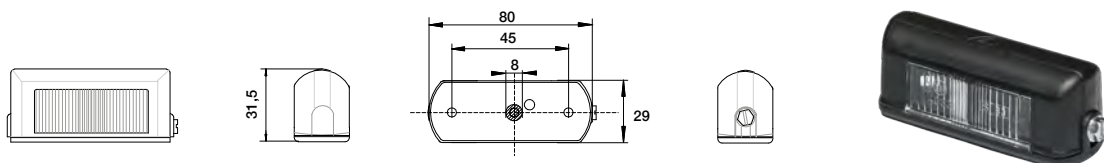

BEST. NR		BEZEICHNUNG	←	→			ANSCHLUSS		mm	
PART NO		DESCRIPTION					CONNECTOR			
42-4101-001	1/600	Kennzeichenleuchte Number plate light	●	●	●	12-24	Tülle grommet			12
42-4101-011	1/600	Kennzeichenleuchte Number plate light + Schrauben +screws	●	●	●	12-24	Tülle grommet			12

42-500

INNENLEUCHE INTERIOR LAMPS

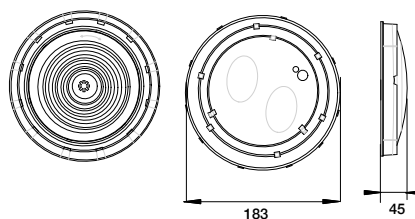
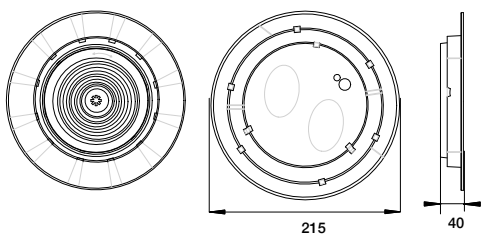

BEST. NR PART NO	1/22	BEZEICHNUNG DESCRIPTION	V	ANSCHLUSS CONNECTOR	ABBILDUNG PICTURE	mm
42-5000-001	1/22	Innenleuchte Einbauversion Interior lamp recessed	12-24	Kabelloch cable hole		10
42-5000-101	1/22	Innenleuchte Aufbauversion Interior lamp surface mount	12-24	Kabelloch cable hole		10

LED KONTROLLGERÄT LED CONTROL GEAR

IP 67 EMC

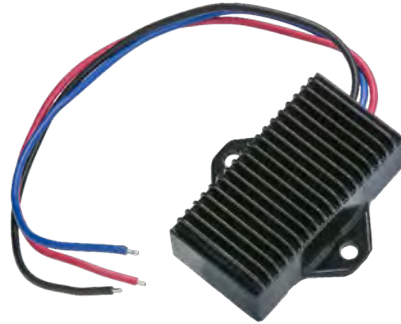
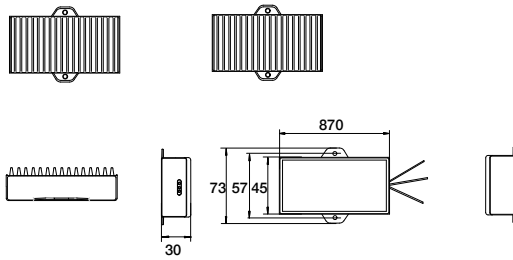

BEST. NR					ZUSATZFUNKTION	ANSCHLUSS	
PART NO					SPECIAL FUNCTION	CONNECTOR	
42-9000-001	1/50	●	●	24	Blinklicht Erkennung DI detection	offenes Ende open end	0,28 m
42-9000-101	1/50	●	●	12	Blinklicht Erkennung DI detection	offenes Ende open end	0,28 m

OE article no.	OE	Fabrilcar	page
324944	Kögel	41-1071-001	22
324945	Kögel	41-1070-001	22
333423	Kögel	41-1073-001	22
1272653	DAF	41-1000-001	8
1284213	DAF	41-1006-211	9
1304788	DAF	41-1007-121	10
1304789	DAF	41-1007-211	10
1350343	Scania	41-1000-001	6
1365963	Scania	41-1002-211	7
1365964	Scania	41-1002-121	7
1380819	Scania	41-1020-001	14
1436867	Scania	41-1022-211	16
1436868	Scania	41-1022-021	16
1498102	Scania	41-1021-411	15
1498103	Scania	41-1021-301	15
1545607	Scania	41-1021-521	15
1625985	DAF	41-1001-211	6
1625986	DAF	41-1001-121	6
1626319	DAF	41-1006-211	9
3981455	Volvo	41-1021-111	14
3981456	Volvo	41-1021-001	14
3981782	Volvo	41-1020-001	14
4808772	Iveco	41-1081-121	23
4808773	Iveco	41-1081-011	23
4808774	Iveco	41-1081-121	23
4808775	Iveco	41-1081-011	23
7984794	Iveco	41-1080-211	23
7984796	Iveco	41-1080-011	23
7984797	Iveco	41-1080-121	23
8191747	Volvo	41-1008-211	11
8191748	Volvo	41-1008-321	11
20425728	Volvo	41-1031-211	17
20425729	Volvo	41-1031-021	17
20425730	Volvo	41-1031-021	17
20425732	Volvo	41-1030-001	17
20507623	Volvo	41-1031-211	17
20565103	Volvo	41-1041-311	18
20565105	Volvo	41-1041-011	18
20565106	Volvo	41-1041-121	18
20565107	Volvo	41-1040-001	18
42555131	Iveco	41-1090-001	24
42555131	Iveco	41-1090-001	24
42555132	Iveco	41-1090-001	24
69500026	Iveco	41-1091-121	24

OE article no.	OE	Fabrilcar	page
69500032	Iveco	41-1091-011	24
93161844	Iveco	41-1000-001	6
99463242	Iveco	41-1009-221	12
99463242	Iveco	41-1080-011	23
99463243	Iveco	41-1009-011	12
99463244	Iveco	41-1009-111	12
500356782	Iveco	41-1083-121	23
500356783	Iveco	41-1083-011	23
5000296594	Renault	41-1000-001	6
5001847584	Renault	41-1001-211	6
5001847585	Renault	41-1001-121	6
5001847588	Renault	41-1000-001	6
81252256464	MAN	41-1006-011	9
81252256464	MAN	41-1006-121	9
81252256465	MAN	41-1006-211	9
81252256524	MAN	41-1001-211	6
81252256526	MAN	41-1001-011	6
81252286029	MAN	41-1006-211	9
81252286030	MAN	41-1006-011	9
81252286030	MAN	41-1006-121	9
81252286033	MAN	41-1006-011	9
81252286033	MAN	41-1006-121	9
81252286033	MAN	41-1006-211	9
81252296051	MAN	41-1000-001	6
82252256523	MAN	41-1001-121	6
.0015401770	Mercedes	41-1052-211	20
.0015401870	Mercedes	41-1052-121	20
.0015406270	Mercedes	41-1051-411	19
.0015406370	Mercedes	41-1051-521	19
.0025441290	Mercedes	41-1050-011	19
.0025441690	Mercedes	41-1050-121	19
.062345	Schmitz	41-1071-001	22
.062423	Schmitz	41-1071-001	22
.062447	Schmitz	41-1070-001	22
A0025444790	Mercedes	41-1060-001	21
A0025445303	Mercedes	41-1062-311	21
A0025445403	Mercedes	41-1062-021	21
A0025445403	Mercedes	41-1062-111	21
A0025445503	Mercedes	41-1061-311	21
A0025445603	Mercedes	41-1062-311	21
A0025445703	Mercedes	41-1062-021	21
A0025445703	Mercedes	41-1062-111	21
A0026555304	Mercedes	41-1061-021	21
A0035444790	Mercedes	41-1060-001	21

OE	OE article no.	Fabrilcar	page
DAF	1272653	41-1000-001	6
DAF	1284213	41-1006-211	6
DAF	1304788	41-1007-121	6
DAF	1304789	41-1007-211	9
DAF	1625985	41-1001-211	9
DAF	1625986	41-1001-121	10
DAF	1626319	41-1006-211	10
Iveco	4808772	41-1081-121	6
Iveco	4808773	41-1081-011	12
Iveco	4808774	41-1081-121	12
Iveco	4808775	41-1081-011	12
Iveco	7984794	41-1080-211	23
Iveco	7984796	41-1080-011	23
Iveco	7984797	41-1080-121	23
Iveco	42555131	41-1090-001	24
Iveco	42555131	41-1090-001	24
Iveco	42555132	41-1090-001	24
Iveco	69500026	41-1091-121	24
Iveco	69500032	41-1091-011	24
Iveco	93161844	41-1000-001	23
Iveco	99463242	41-1009-221	23
Iveco	99463242	41-1080-011	23
Iveco	99463243	41-1009-011	23
Iveco	99463244	41-1009-111	23
Iveco	500356782	41-1083-121	23
Iveco	500356783	41-1083-011	23
Kögel	324944	41-1071-001	22
Kögel	324945	41-1070-001	22
Kögel	333423	41-1073-001	22
MAN	81252256464	41-1006-011	6
MAN	81252256464	41-1006-121	6
MAN	81252256465	41-1006-211	6
MAN	81252256524	41-1001-211	6
MAN	81252256526	41-1001-011	9
MAN	81252286029	41-1006-211	9
MAN	81252286030	41-1006-011	9
MAN	81252286030	41-1006-121	9
MAN	81252286033	41-1006-011	9
MAN	81252286033	41-1006-121	9
MAN	81252286034	41-1006-211	9
MAN	81252296051	41-1000-001	9
MAN	82252256523	41-1001-121	9
Mercedes	.0015401770	41-1052-211	19
Mercedes	.0015401870	41-1052-121	19

OE	OE article no.	Fabrilcar	page
Mercedes	.0015406270	41-1051-411	19
Mercedes	.0015406370	41-1051-521	19
Mercedes	.0025441290	41-1050-011	20
Mercedes	.0025441690	41-1050-121	20
Mercedes	A0025444790	41-1060-001	21
Mercedes	A0025445303	41-1062-311	21
Mercedes	A0025445403	41-1062-021	21
Mercedes	A0025445403	41-1062-111	21
Mercedes	A0025445503	41-1061-311	21
Mercedes	A0025445603	41-1062-311	21
Mercedes	A0025445703	41-1062-021	21
Mercedes	A0025445703	41-1062-111	21
Mercedes	A0026555304	41-1061-021	21
Mercedes	A0035444790	41-1060-001	21
Renault	5000296594	41-1000-001	6
Renault	5001847584	41-1001-211	6
Renault	5001847585	41-1001-121	6
Renault	5001847588	41-1000-001	6
Scania	1350343	41-1000-001	6
Scania	1365963	41-1002-211	7
Scania	1365964	41-1002-121	7
Scania	1380819	41-1020-001	14
Scania	1436867	41-1022-211	15
Scania	1436868	41-1022-021	15
Scania	1498102	41-1021-411	15
Scania	1498103	41-1021-301	16
Scania	1545607	41-1021-521	16
Schmitz	.062345	41-1071-001	22
Schmitz	.062423	41-1071-001	22
Schmitz	.062447	41-1070-001	22
Volvo	3981455	41-1021-111	11
Volvo	3981456	41-1021-001	11
Volvo	3981782	41-1020-001	14
Volvo	8191747	41-1008-211	14
Volvo	8191748	41-1008-321	14
Volvo	20425728	41-1031-211	17
Volvo	20425729	41-1031-021	17
Volvo	20425730	41-1031-021	17
Volvo	20425732	41-1030-001	17
Volvo	20507623	41-1031-211	17
Volvo	20565103	41-1041-311	18
Volvo	20565105	41-1041-011	18
Volvo	20565106	41-1041-121	18
Volvo	20565107	41-1040-001	18

Fabrilar	OE article no.	OE	page
41-1000-001	1272653	DAF	6
41-1000-001	1350343	Scania	6
41-1000-001	93161844	Iveco	6
41-1000-001	5000296594	Renault	6
41-1000-001	5001847588	Renault	6
41-1000-001	81252296051	MAN	6
41-1001-011	81252256526	MAN	6
41-1001-121	1625986	DAF	6
41-1001-121	5001847585	Renault	6
41-1001-121	82252256523	MAN	6
41-1001-211	1625985	DAF	6
41-1001-211	5001847584	Renault	6
41-1001-211	81252256524	MAN	6
41-1002-121	1365964	Scania	7
41-1002-211	1365963	Scania	7
41-1006-011	81252256464	MAN	9
41-1006-011	81252286030	MAN	9
41-1006-011	81252286033	MAN	9
41-1006-121	81252256464	MAN	9
41-1006-121	81252286030	MAN	9
41-1006-121	81252286033	MAN	9
41-1006-211	1284213	DAF	9
41-1006-211	1626319	DAF	9
41-1006-211	81252256465	MAN	9
41-1006-211	81252286029	MAN	9
41-1006-211	81252286034	MAN	9
41-1007-121	1304788	DAF	10
41-1007-211	1304789	DAF	10
41-1008-211	8191747	Volvo	11
41-1008-321	8191748	Volvo	11
41-1009-011	99463243	Iveco	12
41-1009-111	99463244	Iveco	12
41-1009-221	99463242	Iveco	12
41-1020-001	1380819	Scania	14
41-1020-001	3981782	Volvo	14
41-1021-001	3981456	Volvo	14
41-1021-111	3981455	Volvo	14
41-1021-301	1498103	Scania	15
41-1021-411	1498102	Scania	15
41-1021-521	1545607	Scania	15
41-1022-021	1436868	Scania	16
41-1022-211	1436867	Scania	16
41-1030-001	20425732	Volvo	17
41-1031-021	20425729	Volvo	17

Fabrilar	OE article no.	OE	page
41-1031-021	20425730	Volvo	17
41-1031-211	20425728	Volvo	17
41-1031-211	20507623	Volvo	17
41-1040-001	20565107	Volvo	18
41-1041-011	20565105	Volvo	18
41-1041-121	20565106	Volvo	18
41-1041-311	20565103	Volvo	18
41-1050-011	.0025441290	Mercedes	19
41-1050-121	.0025441690	Mercedes	19
41-1051-411	.0015406270	Mercedes	19
41-1051-521	.0015406370	Mercedes	19
41-1052-121	.0015401870	Mercedes	20
41-1052-211	.0015401770	Mercedes	20
41-1060-001	A0025444790	Mercedes	21
41-1060-001	A0035444790	Mercedes	21
41-1061-021	A0026555304	Mercedes	21
41-1061-311	A0025445503	Mercedes	21
41-1062-021	A0025445403	Mercedes	21
41-1062-021	A0025445703	Mercedes	21
41-1062-111	A0025445403	Mercedes	21
41-1062-111	A0025445703	Mercedes	21
41-1062-311	A0025445303	Mercedes	21
41-1062-311	A0025445603	Mercedes	21
41-1070-001	324945	Kögel	22
41-1070-001	.062447	Schmitz	22
41-1071-001	324944	Kögel	22
41-1071-001	.062345	Schmitz	22
41-1071-001	.062423	Schmitz	22
41-1073-001	333423	Kögel	22
41-1080-011	7984796	Iveco	23
41-1080-011	99463242	Iveco	23
41-1080-121	7984797	Iveco	23
41-1080-211	7984794	Iveco	23
41-1081-011	4808773	Iveco	23
41-1081-011	4808775	Iveco	23
41-1081-121	4808772	Iveco	23
41-1081-121	4808774	Iveco	23
41-1083-011	500356783	Iveco	23
41-1083-121	500356782	Iveco	23
41-1090-001	42555131	Iveco	24
41-1090-001	42555131	Iveco	24
41-1090-001	42555132	Iveco	24
41-1091-011	69500032	Iveco	24
41-1091-121	69500026	Iveco	24

Bestellnummernübersicht / Part numbers summary



BEST. NR PART NO	Seite page	BEST. NR PART NO	Seite page	BEST. NR PART NO	Seite page	BEST. NR PART NO	Seite page
41-1000-001	6	41-1022-111	16	41-1321-001	33	42-3474-241	52
41-1000-001	7	41-1022-211	16	41-1331-001	29	42-3474-251	52
41-1000-001	8	41-1022-321	16	41-1384-011	30	42-3474-261	52
41-1000-001	9	41-1023-021	16	41-1394-011	31	42-3474-271	52
41-1000-001	10	41-1023-111	16	41-1400-004	34	42-4000-001	53
41-1000-001	11	41-1023-211	16	41-2000-001	28	42-4050-001	66
41-1000-001	12	41-1023-321	16	41-2000-011	28	42-4054-001	66
41-1000-101	6	41-1030-001	17	41-2010-001	27	42-4054-011	67
41-1000-101	7	41-1031-021	17	41-2010-011	27	42-4054-021	68
41-1000-101	8	41-1031-121	17	41-2010-021	27	42-4054-051	67
41-1000-101	9	41-1031-211	17	41-2030-001	32	42-4054-061	68
41-1000-101	10	41-1040-001	18	41-2031-001	32	42-4054-071	69
41-1000-101	11	41-1041-011	18	41-2032-001	32	42-4054-081	69
41-1000-101	12	41-1041-121	18	41-2033-001	32	42-4055-001	54
41-1001-011	6	41-1041-221	18	42-1000-001	36	42-4055-011	54
41-1001-121	6	41-1041-311	18	42-1000-101	37	42-4055-301	55
41-1001-211	6	41-1050-011	19	42-1000-251	35	42-4055-311	55
41-1001-321	6	41-1050-011	20	42-1001-001	36	42-4055-601	56
41-1002-011	7	41-1050-121	19	42-1002-001	39	42-4055-611	56
41-1002-121	7	41-1050-121	20	42-1004-001	40	42-4056-001	57
41-1002-211	7	41-1051-011	19	42-1006-001	37	42-4056-011	57
41-1002-321	7	41-1051-121	19	42-1007-001	39	42-4056-031	57
41-1003-011	7	41-1051-211	19	42-1008-001	40	42-4056-301	58
41-1003-121	7	41-1051-321	19	42-1008-301	38	42-4056-311	58
41-1003-211	7	41-1051-411	19	42-1008-401	38	42-4056-321	58
41-1003-321	7	41-1051-521	19	42-1009-001	41	42-4056-331	59
41-1004-011	8	41-1052-011	20	42-1009-011	41	42-4056-351	59
41-1004-121	8	41-1052-121	20	42-1009-401	41	42-4056-601	60
41-1004-211	8	41-1052-211	20	42-1009-501	41	42-4056-611	60
41-1004-321	8	41-1052-321	20	42-1010-001	47	42-4056-621	60
41-1005-011	8	41-1060-001	21	42-1010-011	47	42-4056-631	61
41-1005-121	8	41-1061-021	21	42-1010-101	45	42-4056-651	61
41-1005-211	8	41-1061-111	21	42-1010-111	45	42-4057-001	62
41-1005-321	8	41-1061-221	21	42-1011-001	46	42-4057-011	62
41-1006-011	9	41-1061-311	21	42-1011-011	46	42-4057-301	63
41-1006-121	9	41-1062-021	21	42-1011-101	44	42-4057-311	63
41-1006-211	9	41-1062-111	21	42-1011-111	44	42-4057-601	64
41-1006-321	9	41-1062-221	21	42-1011-201	43	42-4057-611	64
41-1007-011	10	41-1062-311	21	42-1011-211	43	42-4058-001	65
41-1007-121	10	41-1063-021	21	42-1011-301	42	42-4058-011	65
41-1007-211	10	41-1063-111	21	42-1011-311	42	42-4060-101	76
41-1007-321	10	41-1063-221	21	42-1020-001	47	42-4060-111	76
41-1008-011	11	41-1063-311	21	42-1020-011	47	42-4100-001	77
41-1008-121	11	41-1070-001	22	42-1020-101	45	42-4101-001	77
41-1008-211	11	41-1071-001	22	42-1020-111	45	42-4101-011	77
41-1008-321	11	41-1072-001	22	42-1021-001	46	42-4404-011	70
41-1009-011	12	41-1073-001	22	42-1021-011	46	42-4404-031	70
41-1009-111	12	41-1080-011	23	42-1021-101	44	42-4404-041	70
41-1009-221	12	41-1080-121	23	42-1021-111	44	42-4404-051	71
41-1009-321	12	41-1080-211	23	42-1021-201	43	42-4404-061	71
41-1010-001	13	41-1080-321	23	42-1021-211	43	42-4404-131	72
41-1011-011	13	41-1081-011	23	42-1021-301	42	42-4404-151	72
41-1011-121	13	41-1081-121	23	42-1021-311	42	42-4404-161	72
41-1011-211	13	41-1081-211	23	42-2000-001	49	42-4404-231	73
41-1011-321	13	41-1081-321	23	42-2000-501	49	42-4404-251	73
41-1012-011	13	41-1082-011	23	42-2001-001	48	42-4404-261	73
41-1012-121	13	41-1082-121	23	42-3000-004	50	42-4417-001	75
41-1012-211	13	41-1082-211	23	42-3000-104	50	42-4417-011	75
41-1012-321	13	41-1082-321	23	42-3001-004	50	42-4417-021	75
41-1020-001	14	41-1083-011	23	42-3001-104	50	42-4417-031	75
41-1020-001	15	41-1083-121	23	42-3002-004	50	42-4417-041	75
41-1020-001	16	41-1083-211	23	42-3002-104	50	42-4417-051	75
41-1021-001	14	41-1083-321	23	42-3474-001	51	42-4417-061	75
41-1021-111	14	41-1090-001	24	42-3474-041	51	42-4417-071	75
41-1021-221	14	41-1091-011	24	42-3474-051	51	42-4504-001	74
41-1021-301	15	41-1091-121	24	42-3474-061	51	42-4505-001	74
41-1021-411	15	41-1300-011	25	42-3474-101	52	42-5000-001	78
41-1021-521	15	41-1300-121	25	42-3474-141	52	42-5000-101	78
41-1021-601	15	41-1310-011	26	42-3474-151	52	42-9000-001	79
41-1021-611	15	41-1310-041	26	42-3474-161	52	42-9000-101	79
41-1021-621	15	41-1310-121	26	42-3474-171	52		
41-1022-021	16	41-1310-151	26	42-3474-201	52		



Your partner for alternative components

powered by ASPÖCK

